

Rita in fortsatt strålgång.

Strålar parallella med symmetriaxeln bryts i linsen så att de går mot bakre fokus  $F'$  (pos. lins) eller ser ut att komma från bakre fokus  $F'$  (neg. lins).

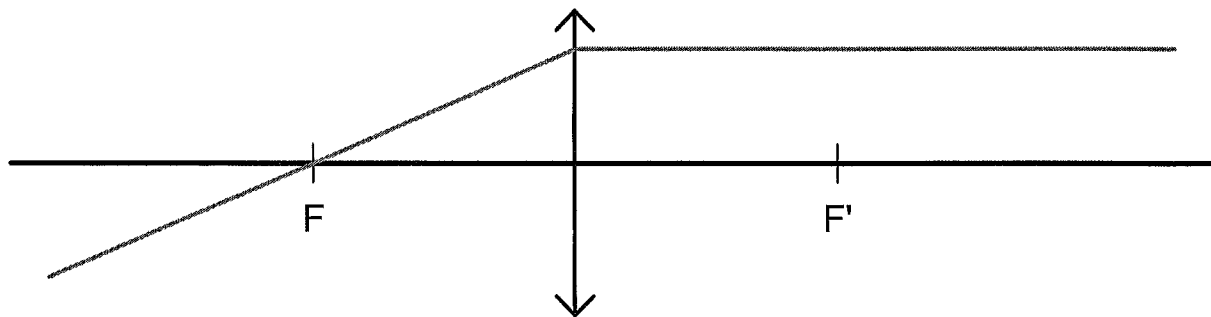

Strålar som går genom främre fokus  $F$  (pos. lins) eller som är på väg mot främre fokus  $F$  (neg. lins) bryts i linsen så att de blir parallella med symmetriaxeln.

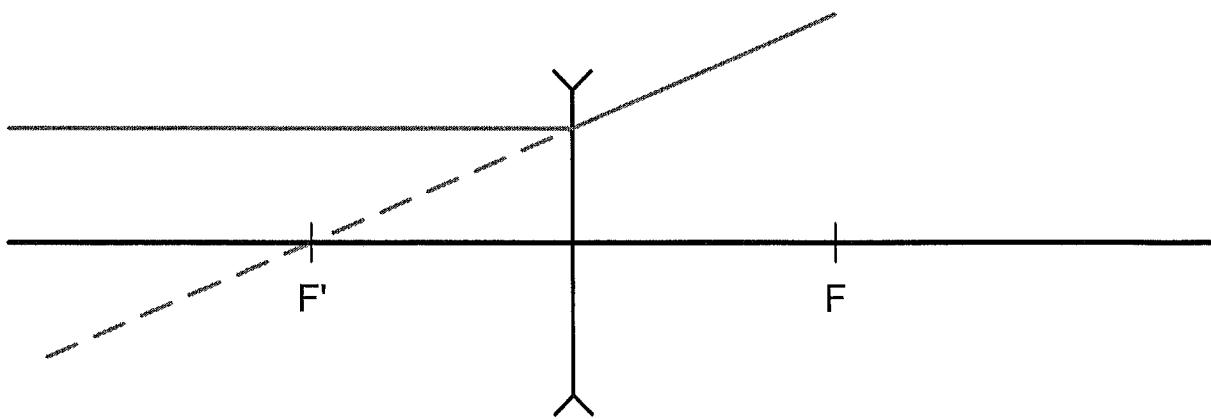
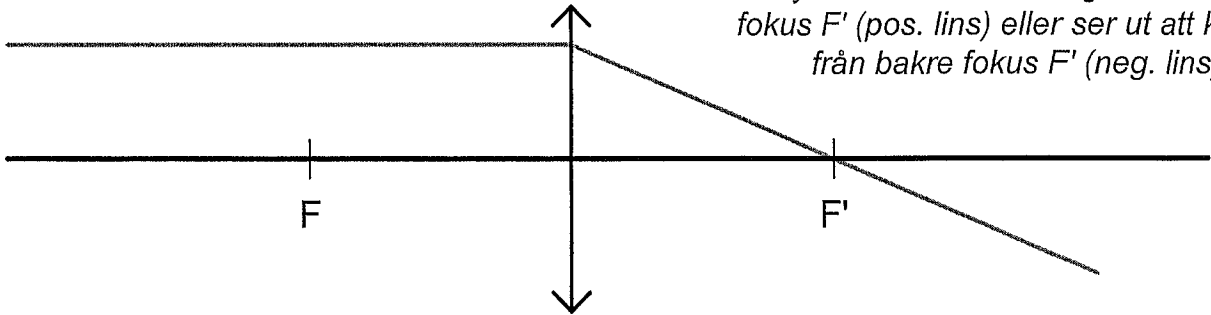
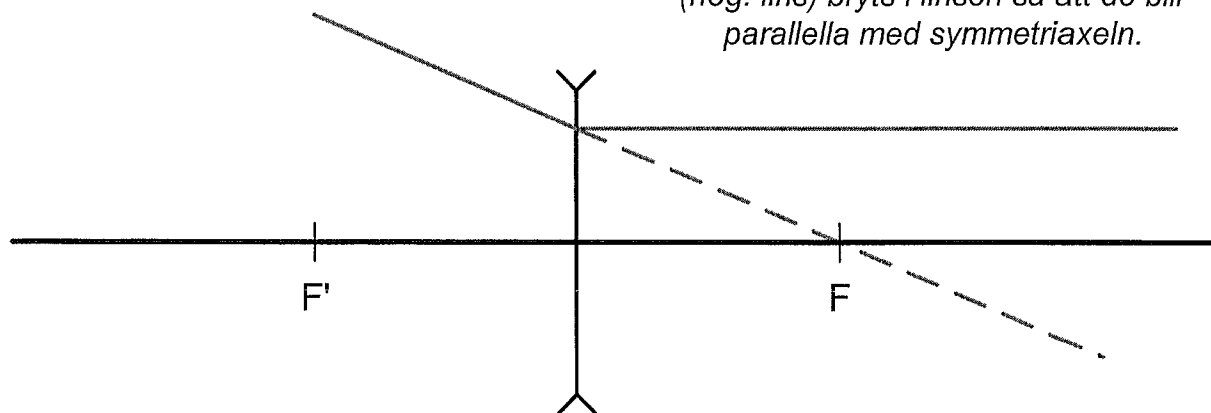

Avbilda objekten.

4'

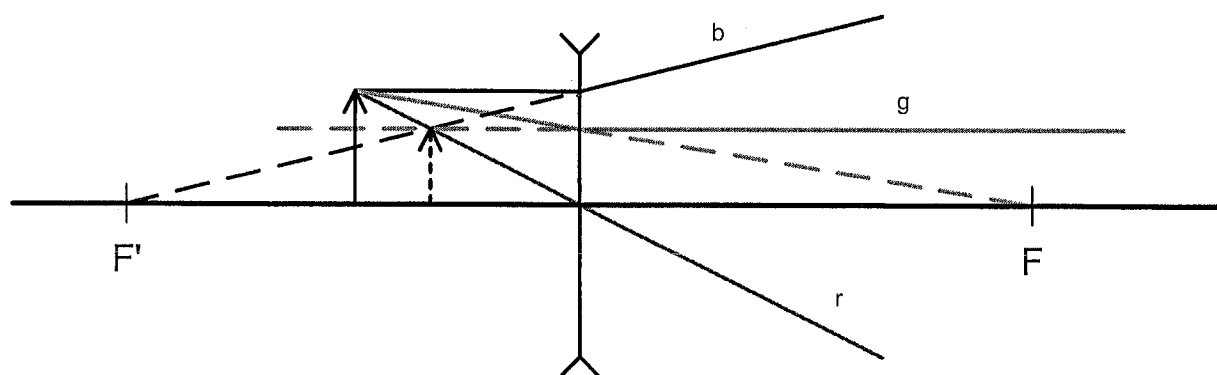
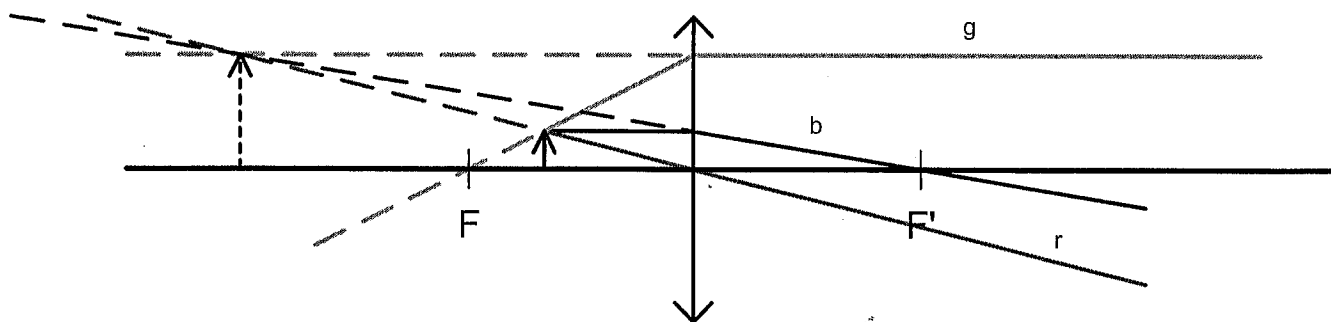
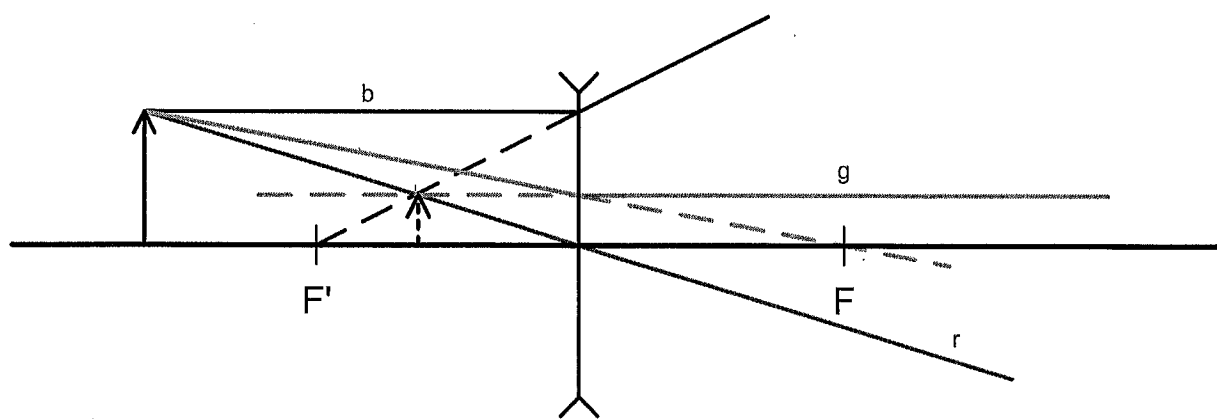
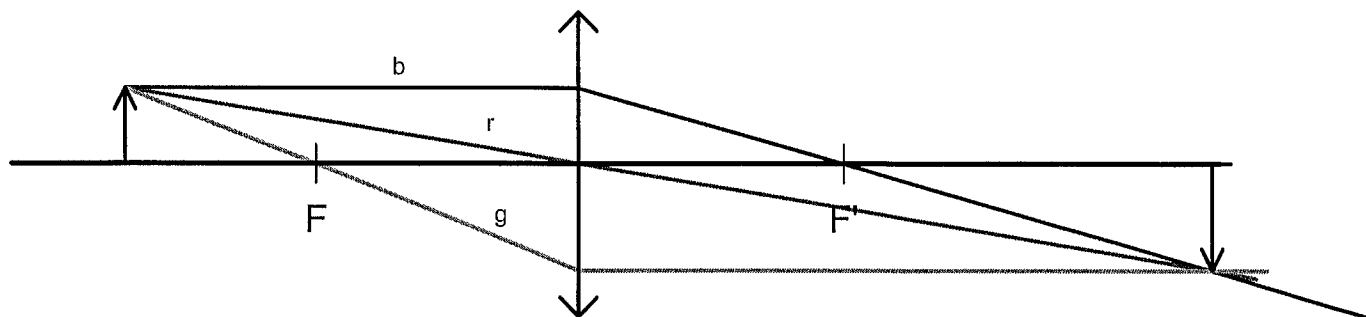

Avbilda objekten.

5'

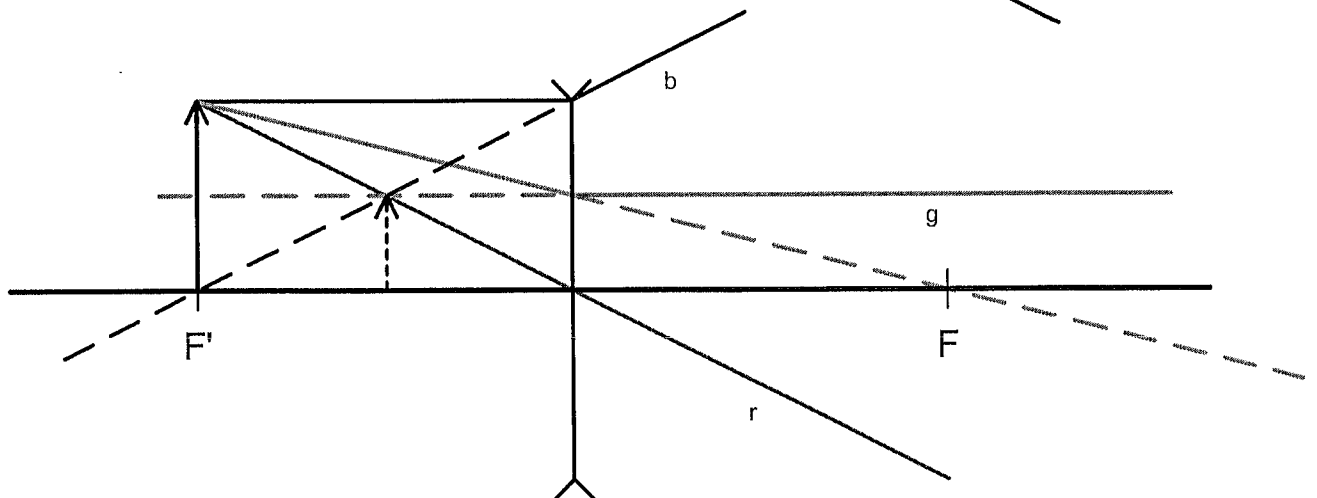
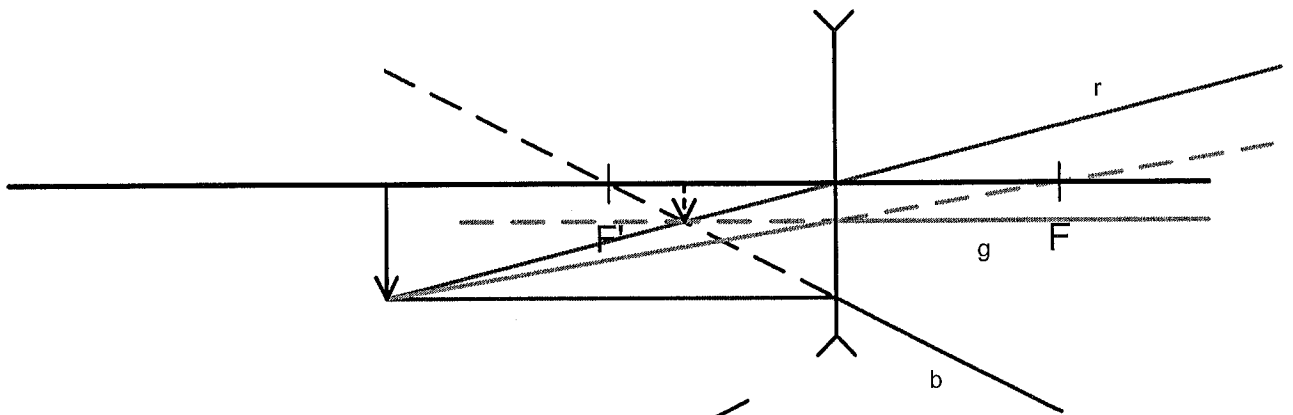
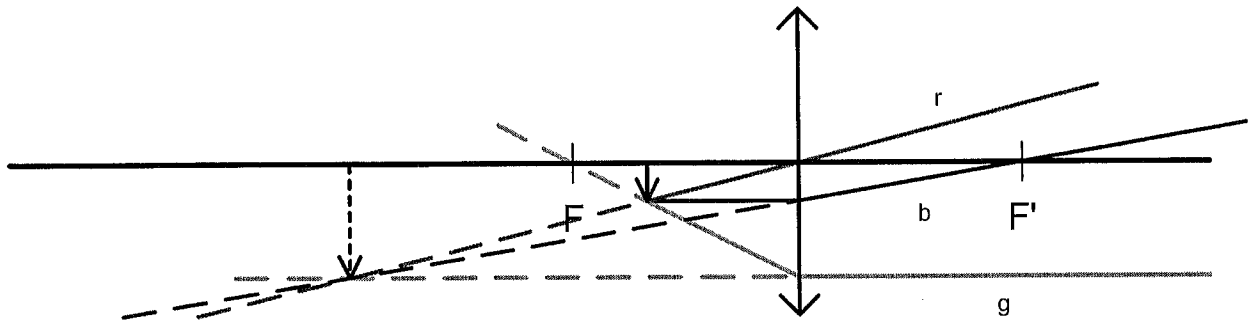
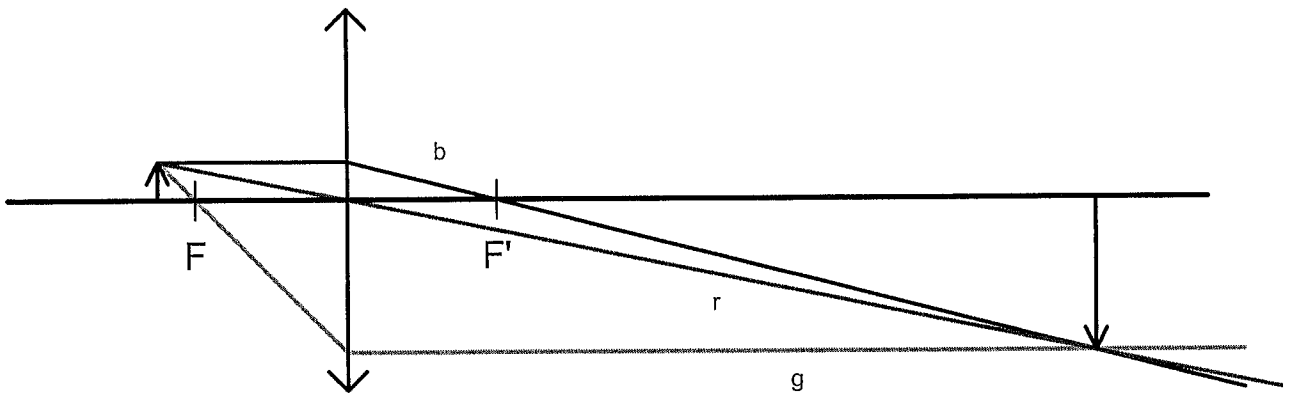

Avbilda objekten.

6'

*Ibland går inte alla typstrålar igenom linsen.  
Linsen avbildar ändå och för konstruktionen  
kan man låta strålar brytas i linsplanet.*

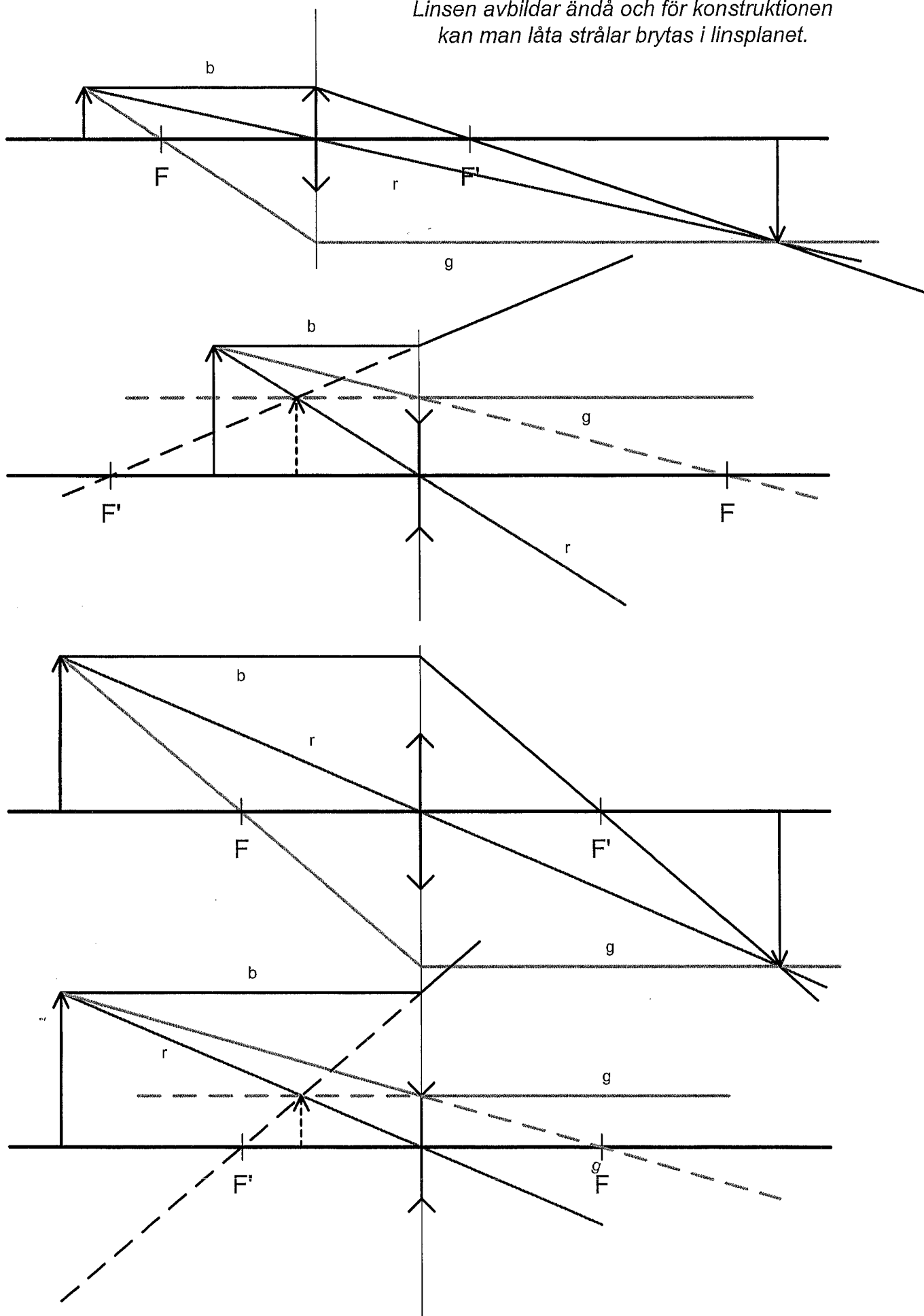

Rita in fortsatt strålgång. Använd hjälpstråle.

7'

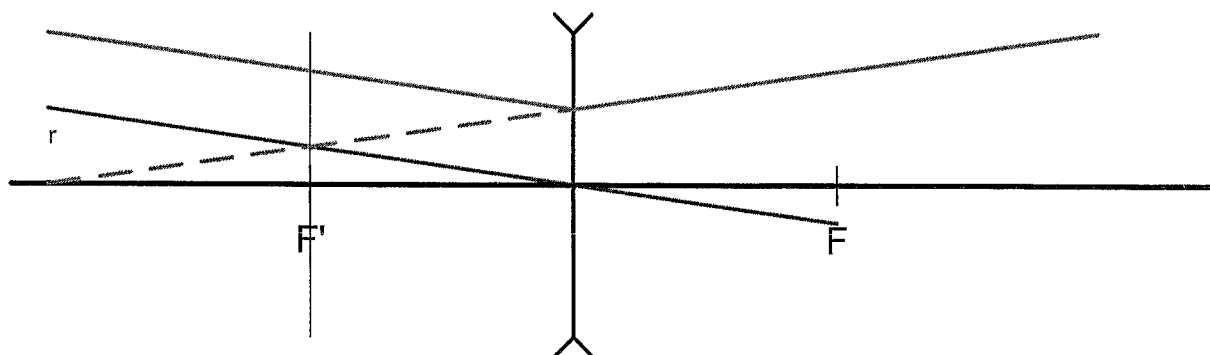
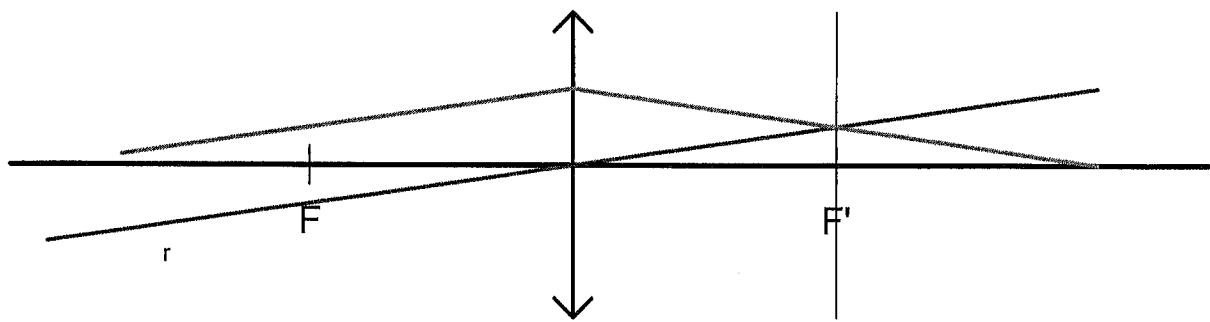
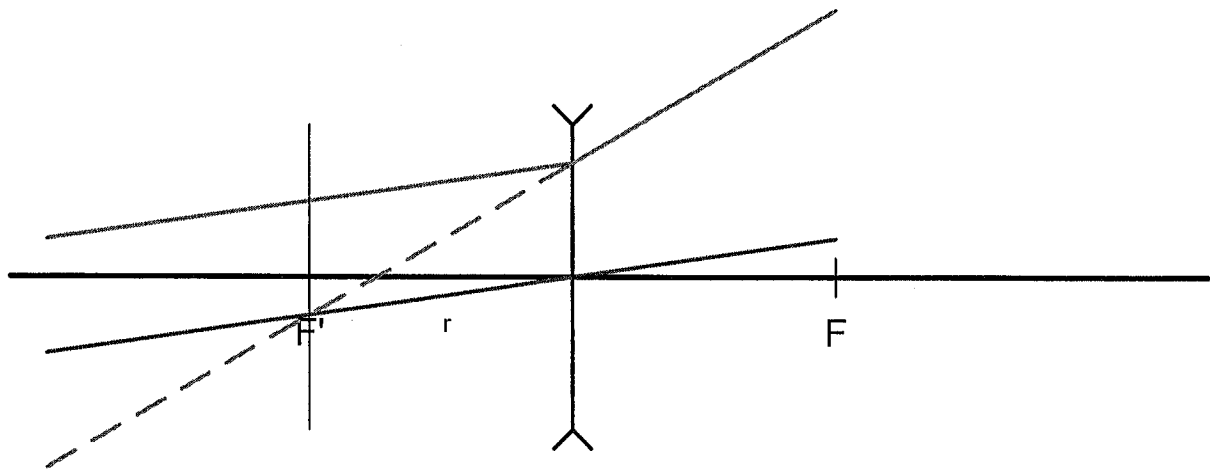
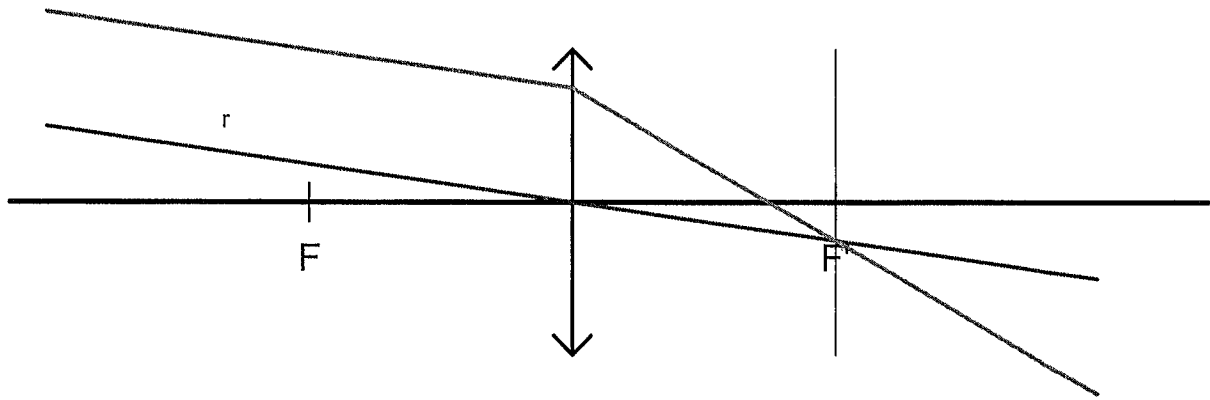

Rita in fortsatt strålgång. Använd hjälpstråle.

8'

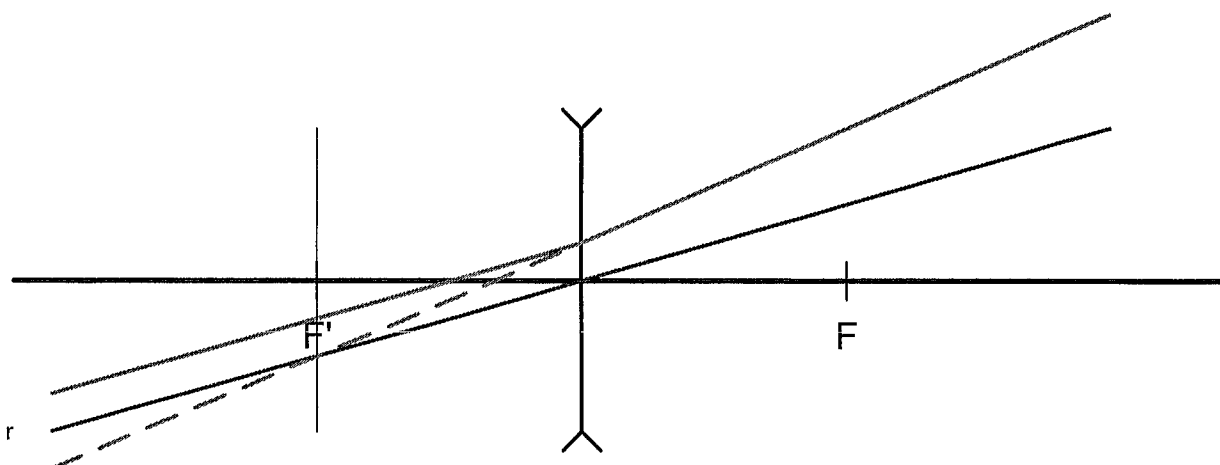
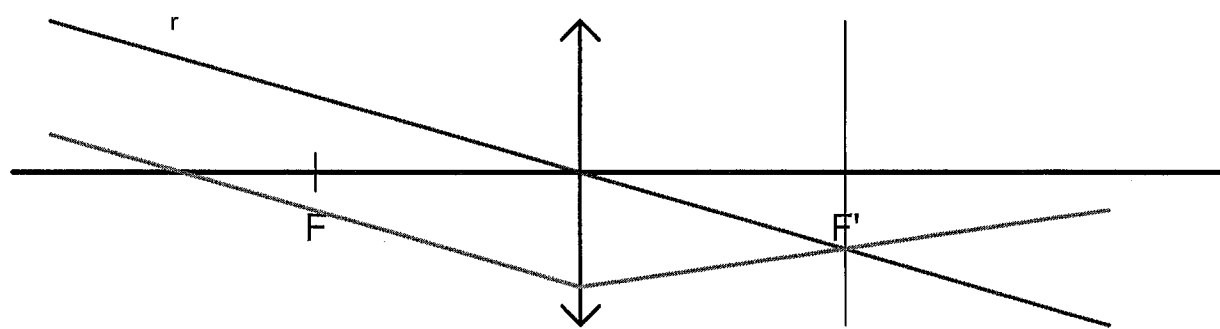
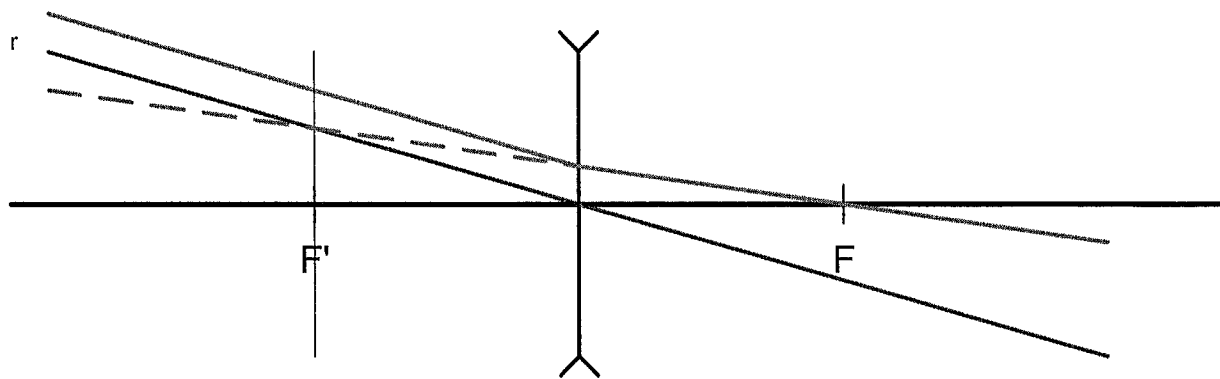
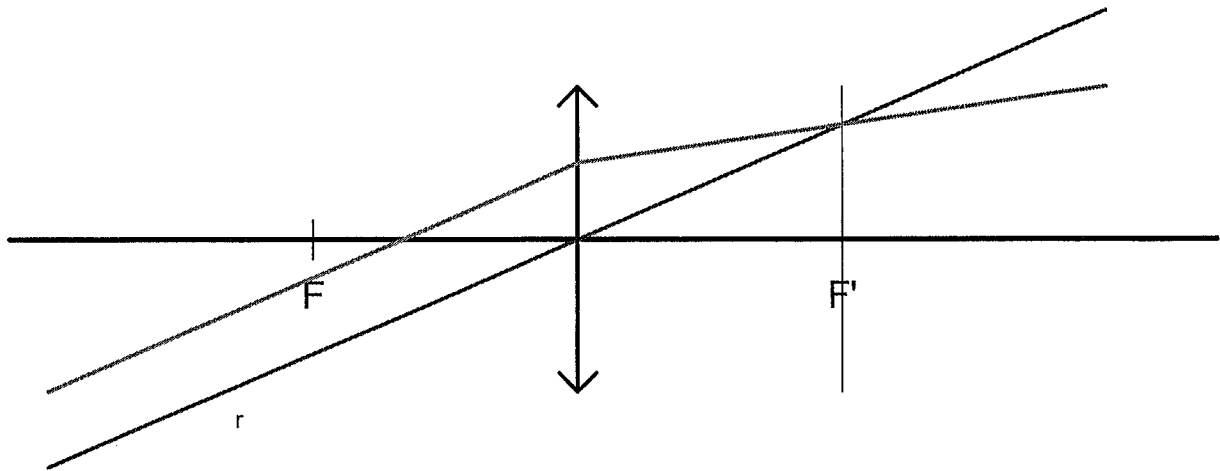

Avbilda de avlägsna objekten.

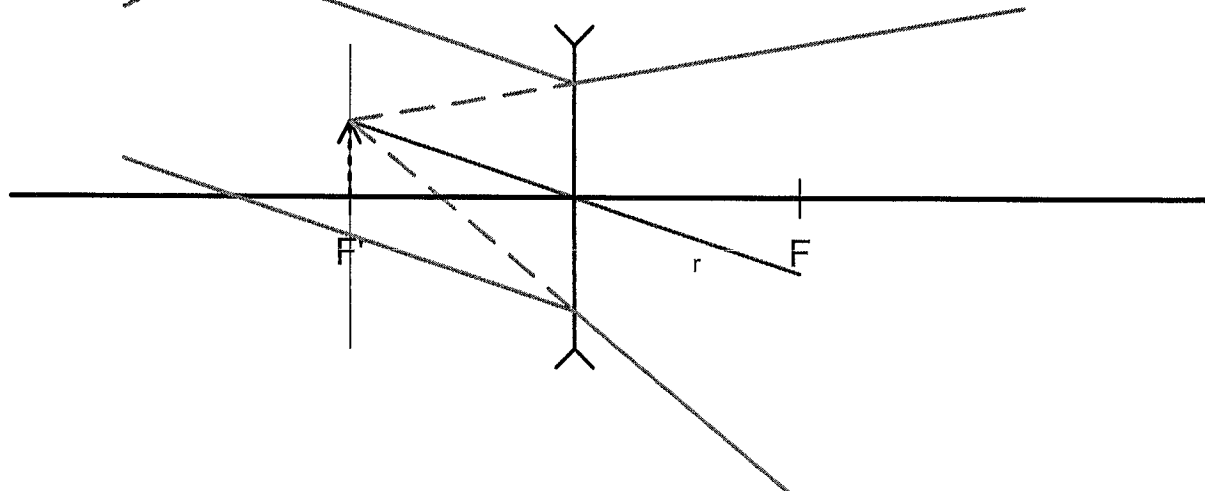
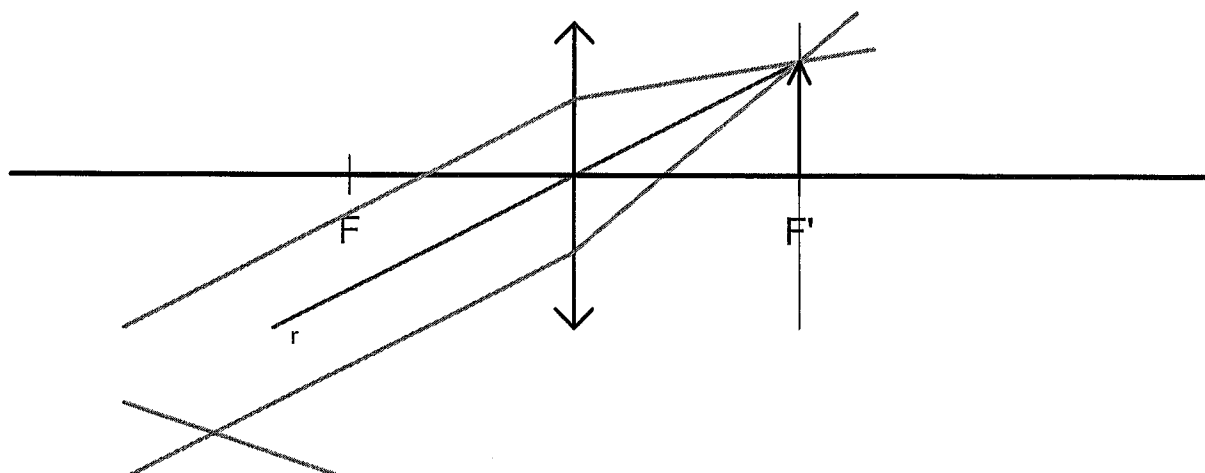
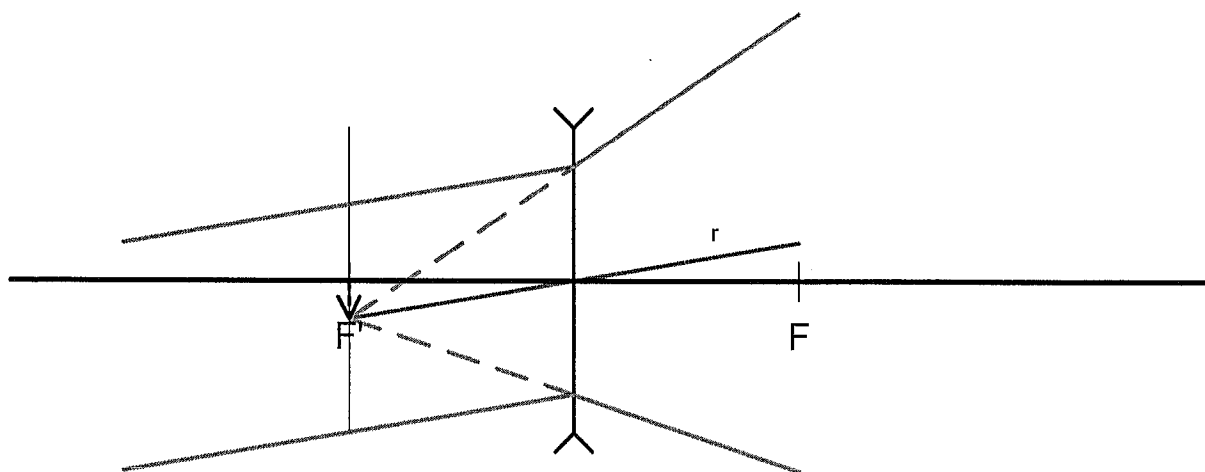
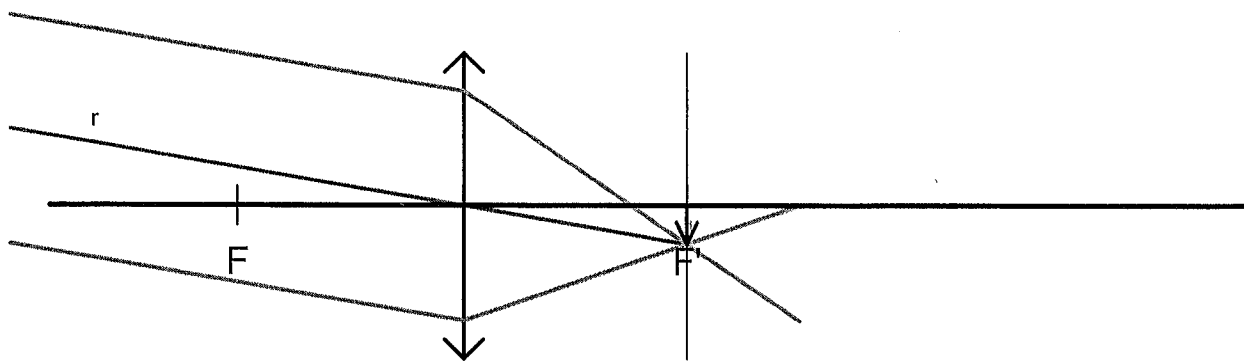

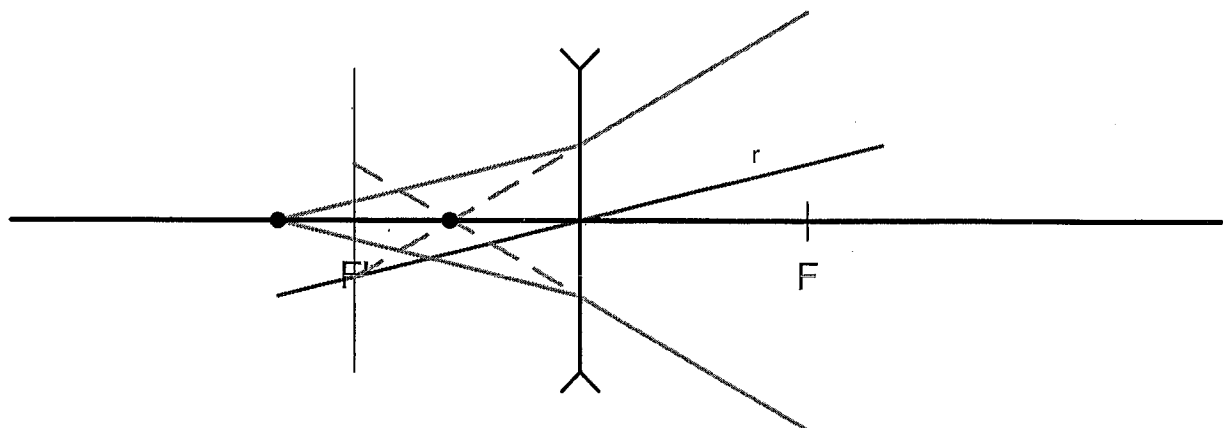
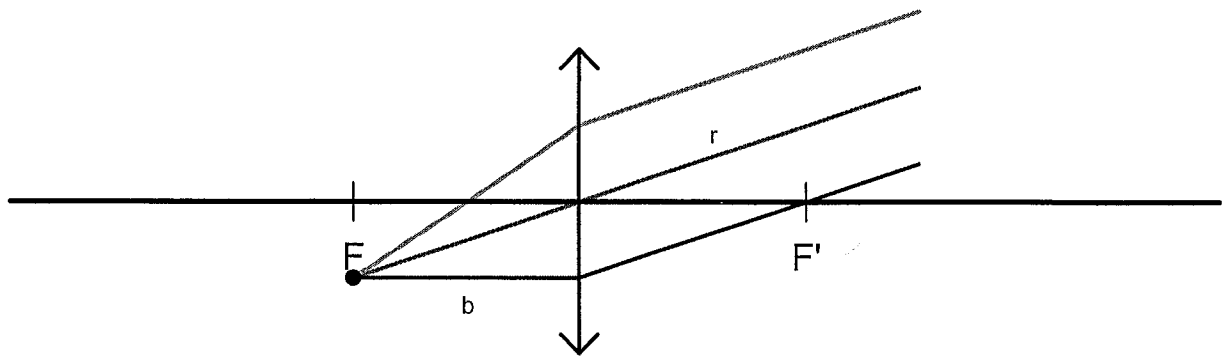
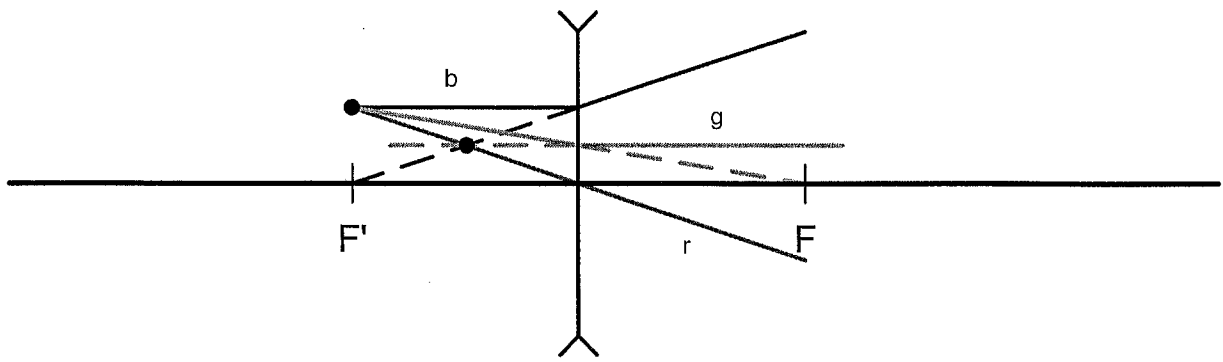
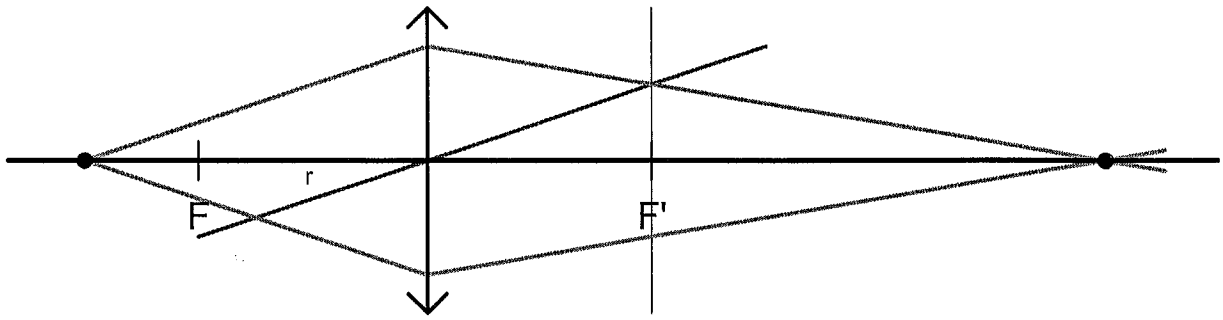



Rita in fortsatt strålgång.

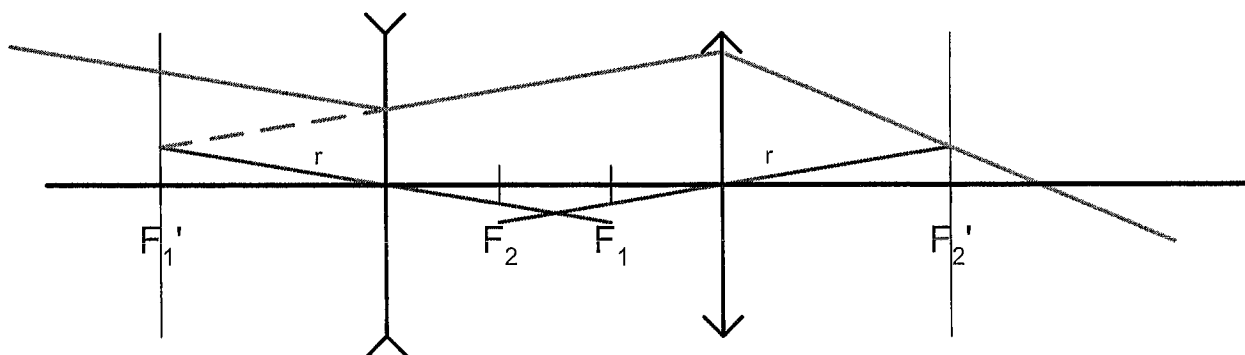
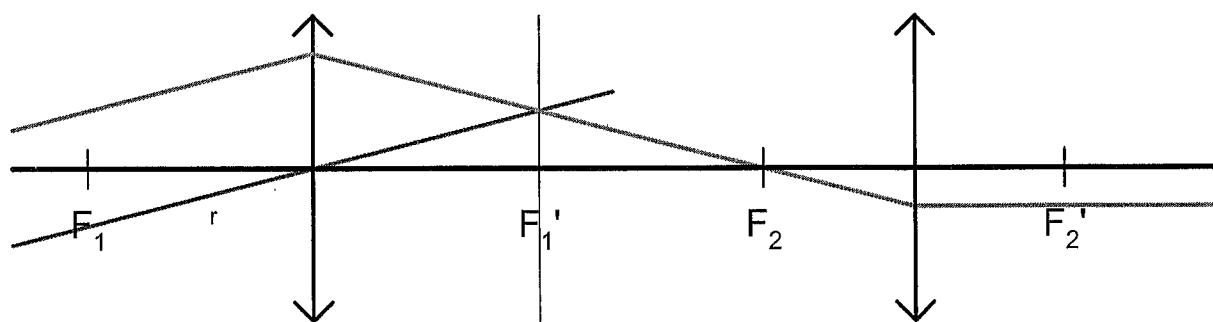
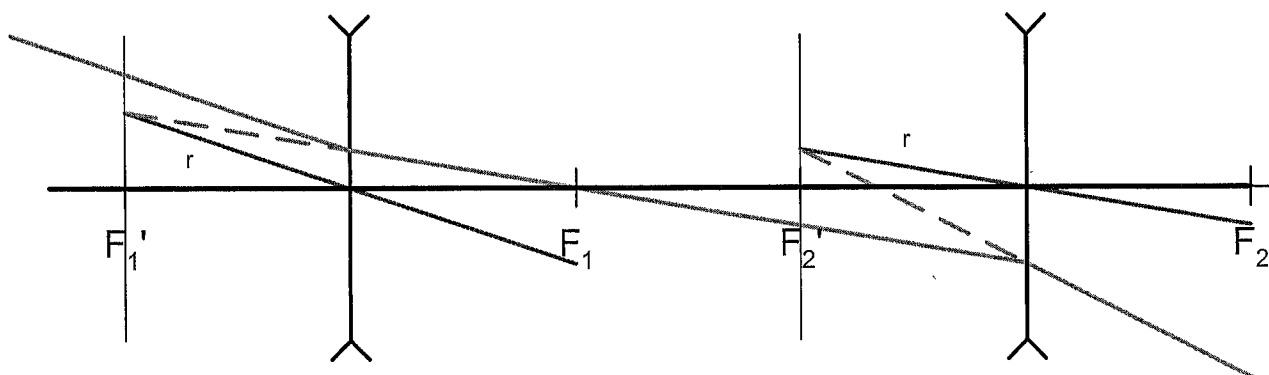
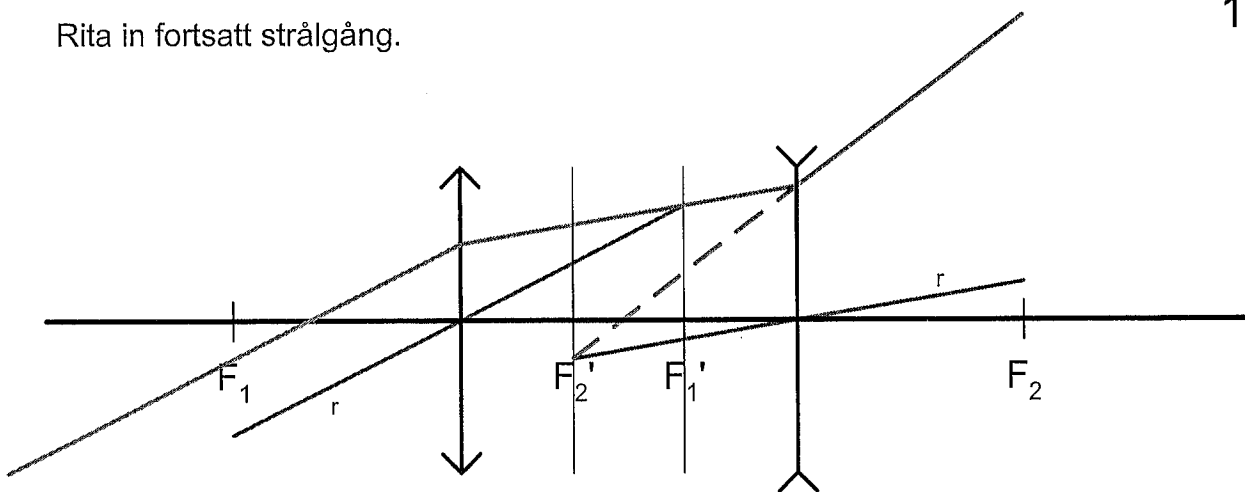

Avbilda objekten.

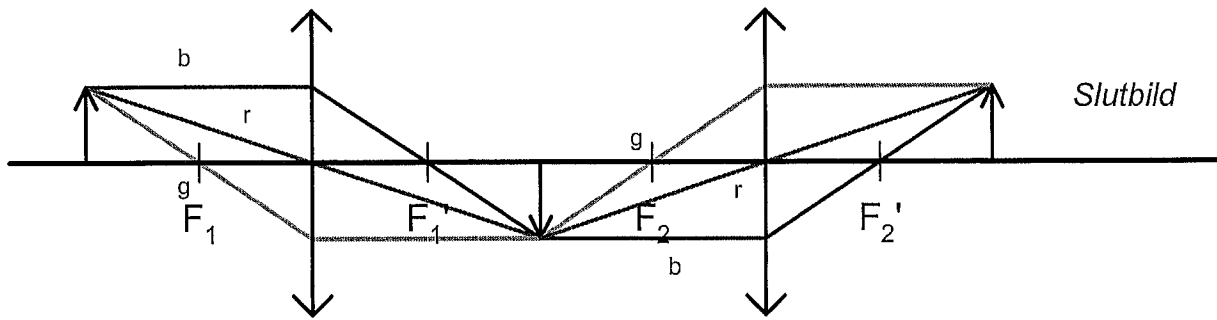

Konstruktionsstrålar och verkliga strålar skiljer sig åt. Ex. blå stråle från första linsen kommer ej igenom andra linsen.

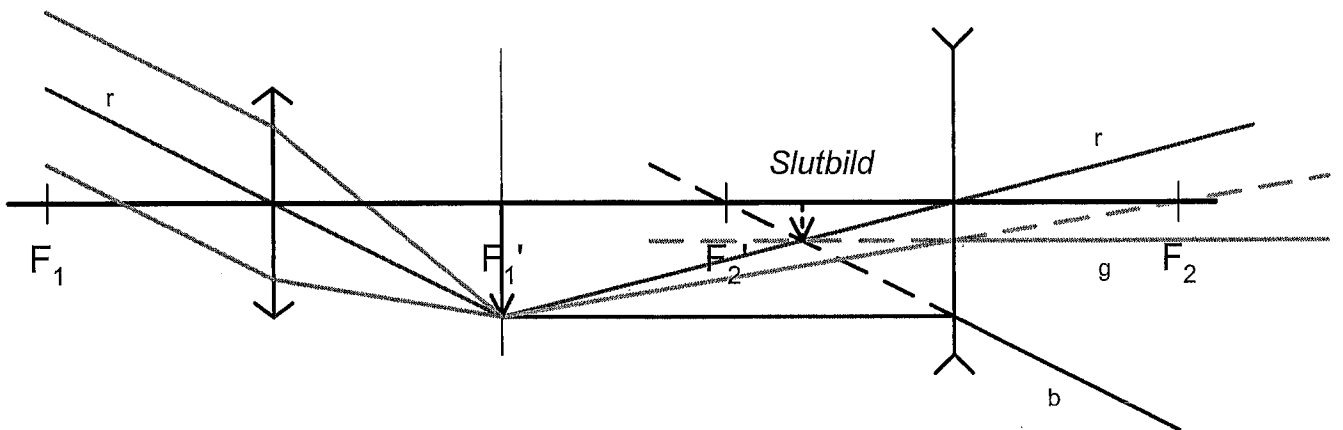

För att veta var slutbilden hamnar avbildar vi i två steg, där mellanbilden blir objekt för andra linsen.

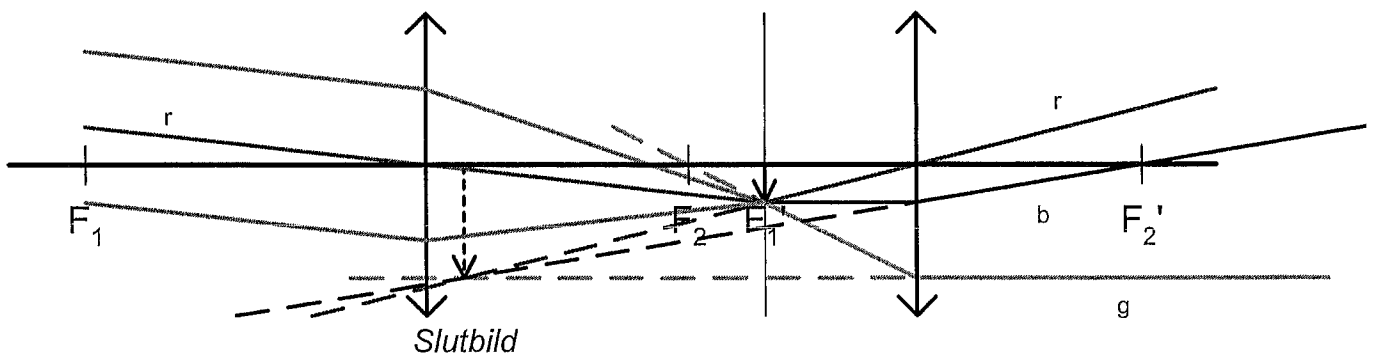
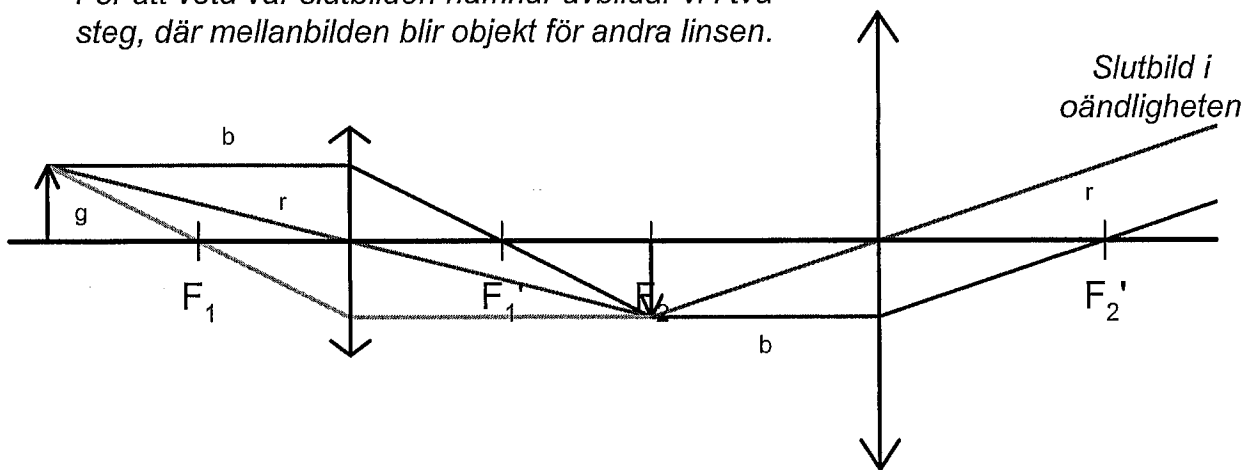

Hitta bakre huvudplan och bakre fokalplan.

15'

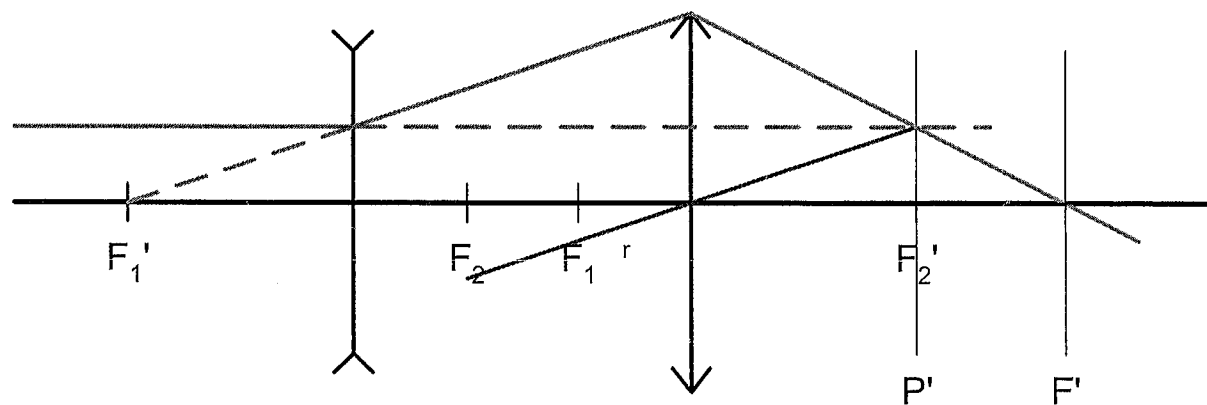
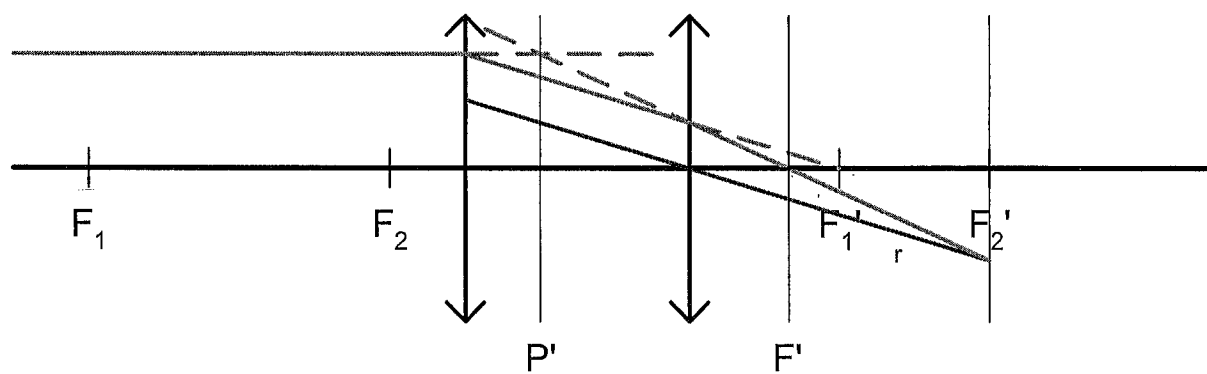
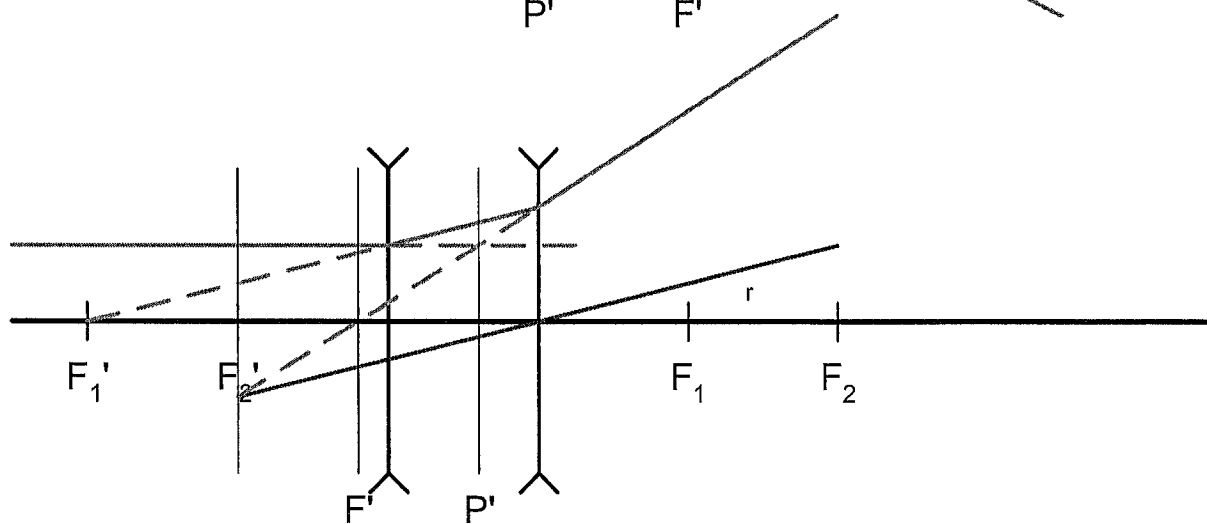
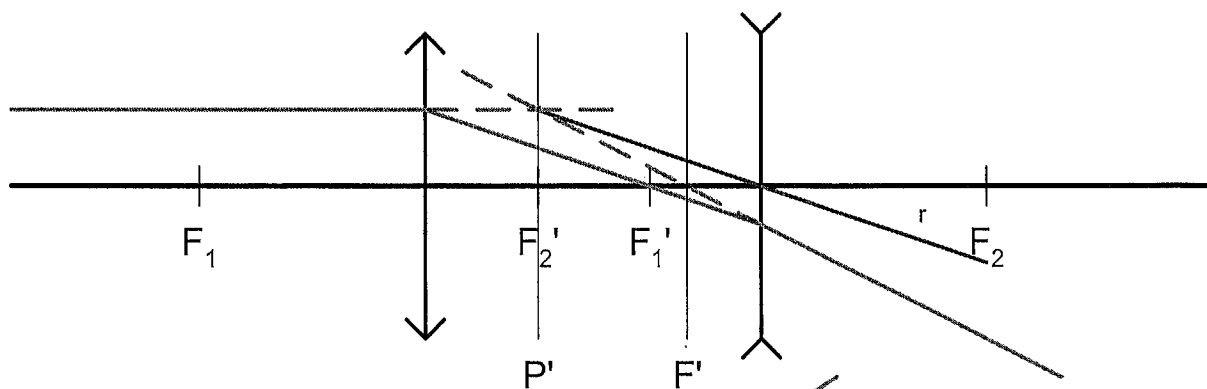

Hitta främre huvudplan och främre fokalplan.

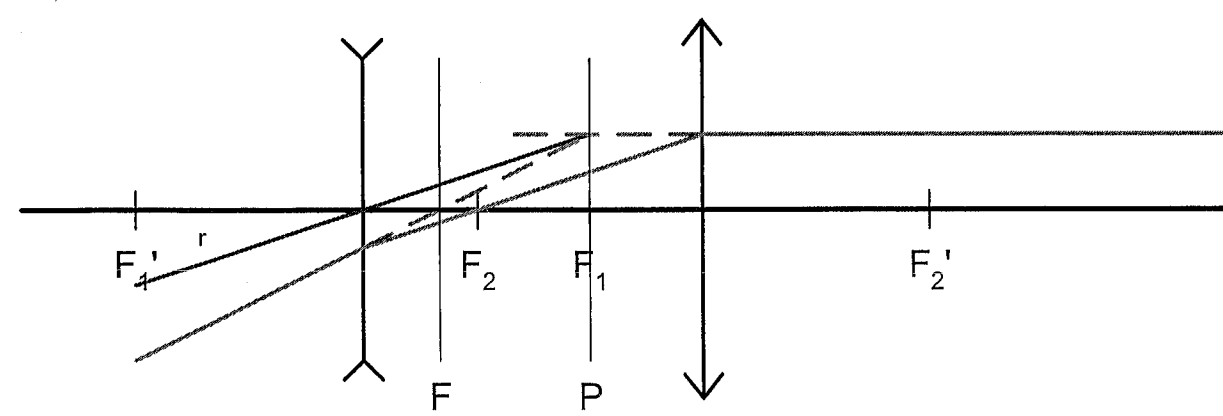
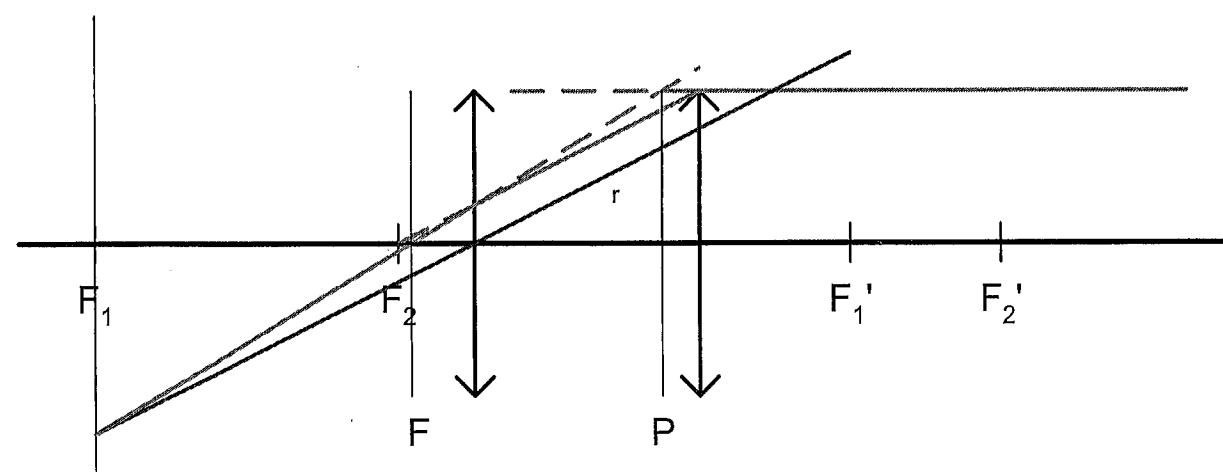
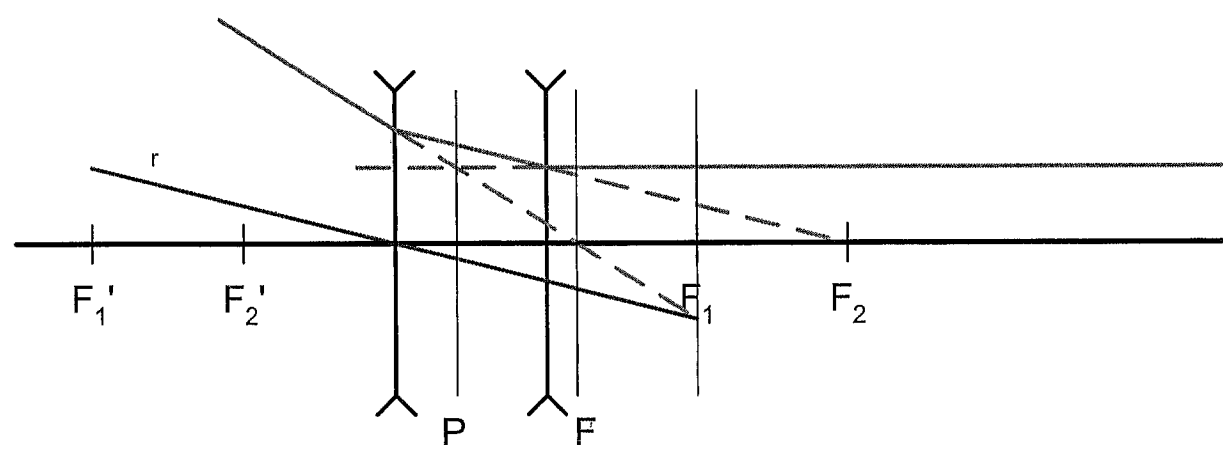
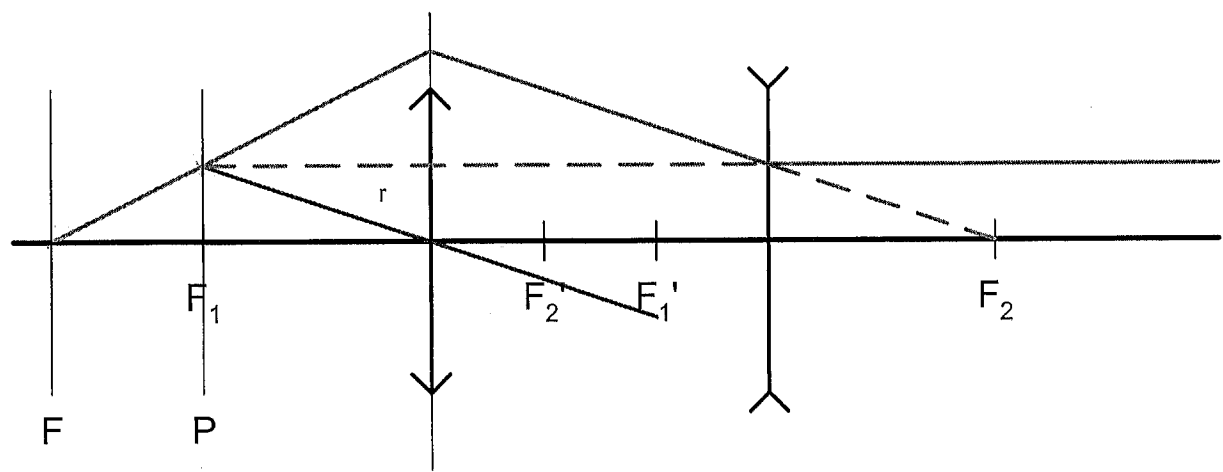

Rita in fortsatt strålgång.

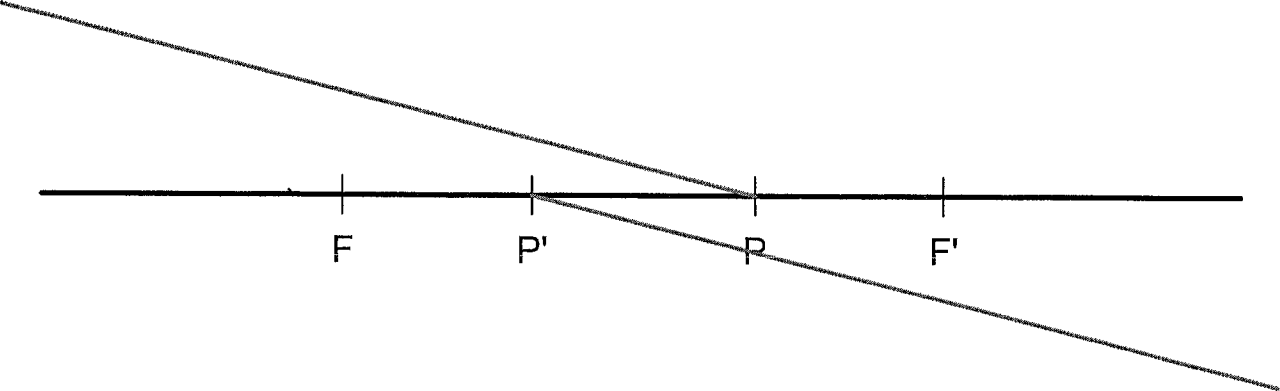
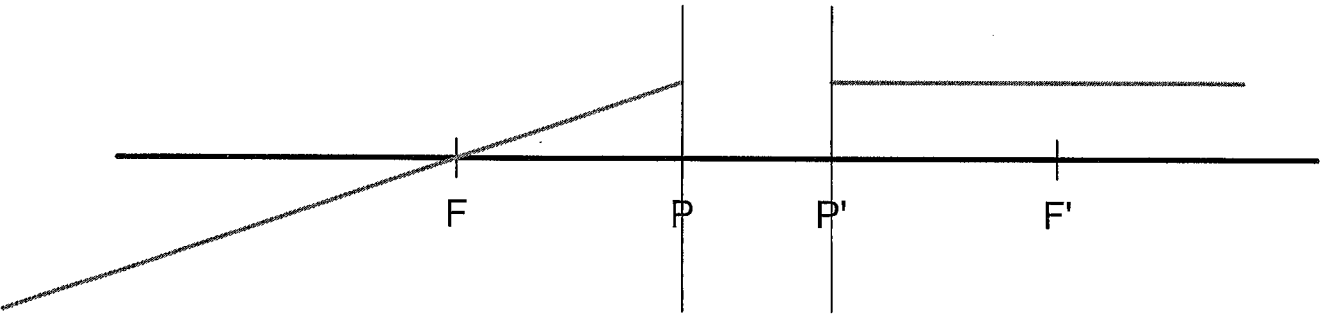
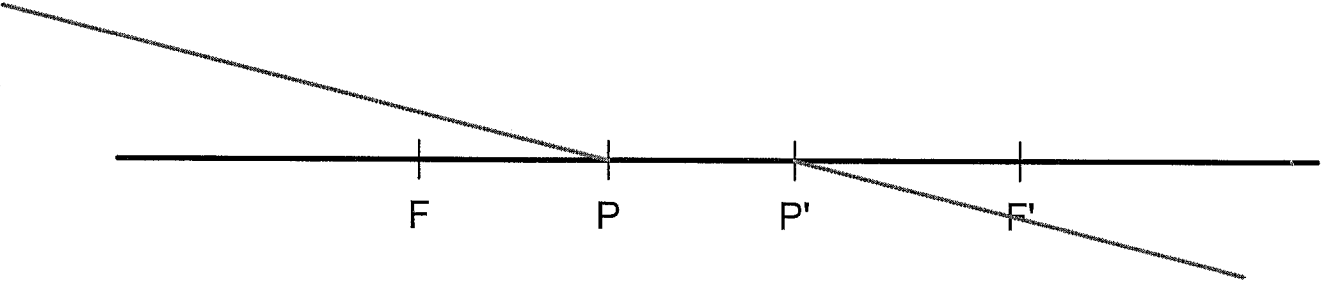
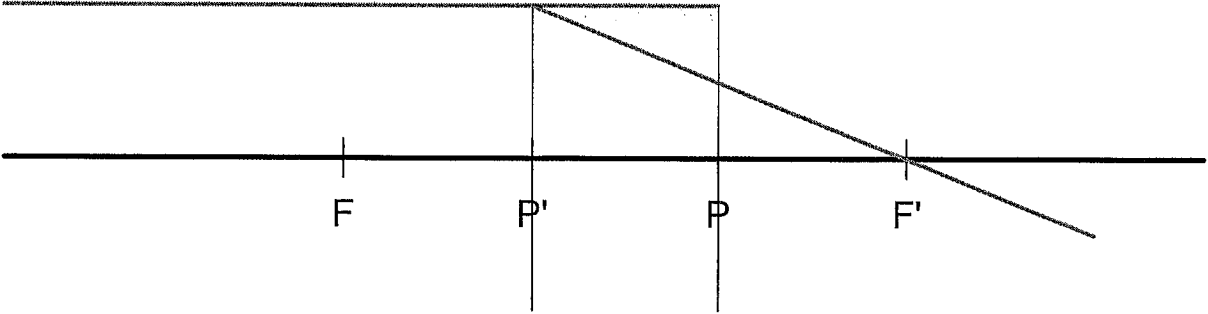

Rita in fortsatt strålgång.

18'

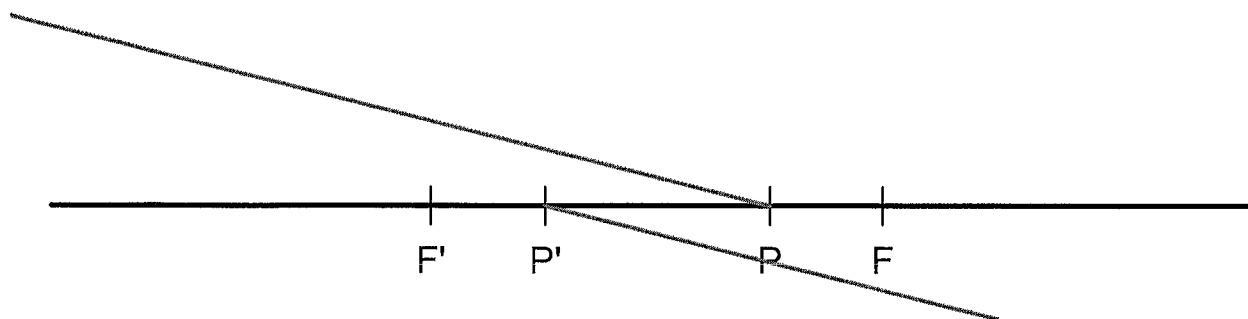
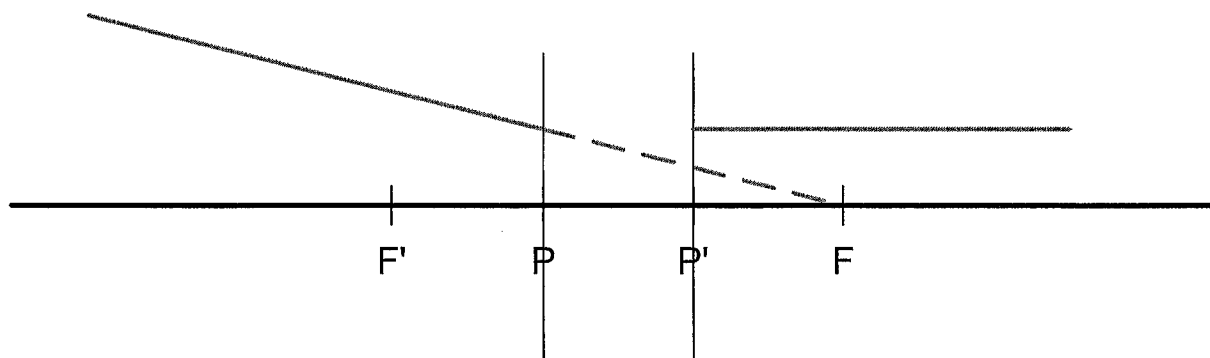
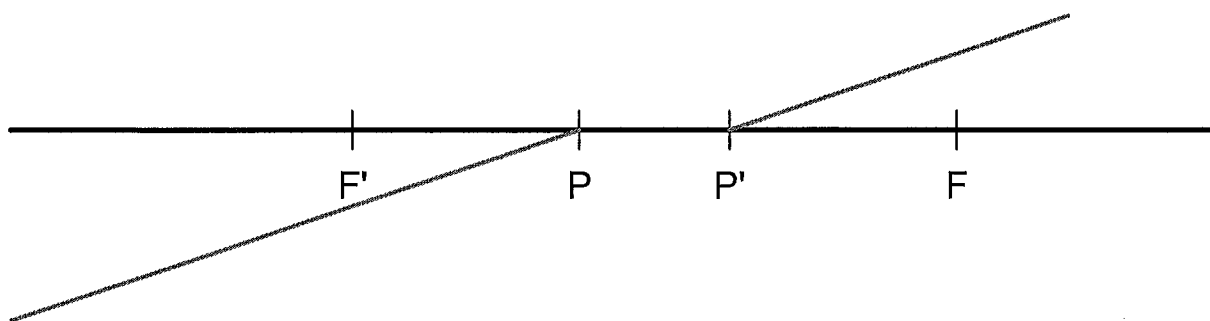
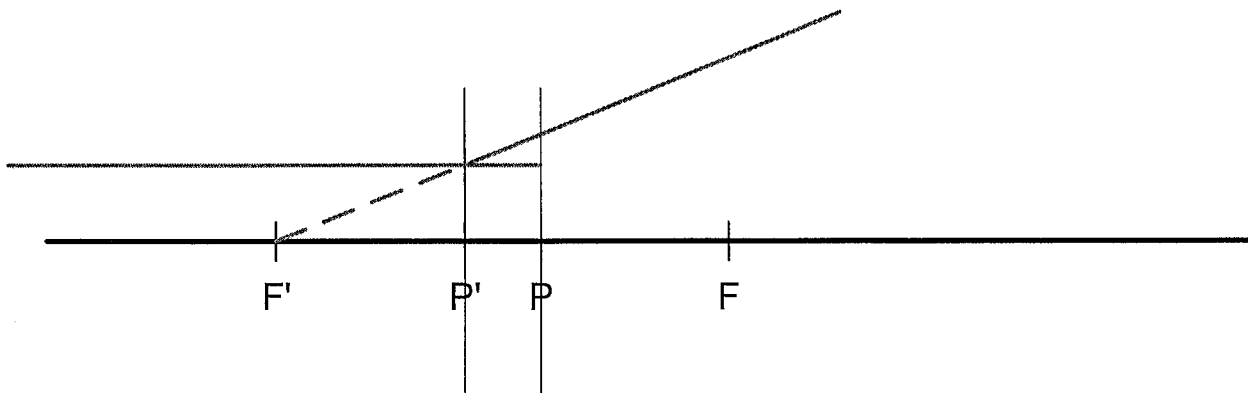

Hitta apertur och fältstopp för objekten.

16'

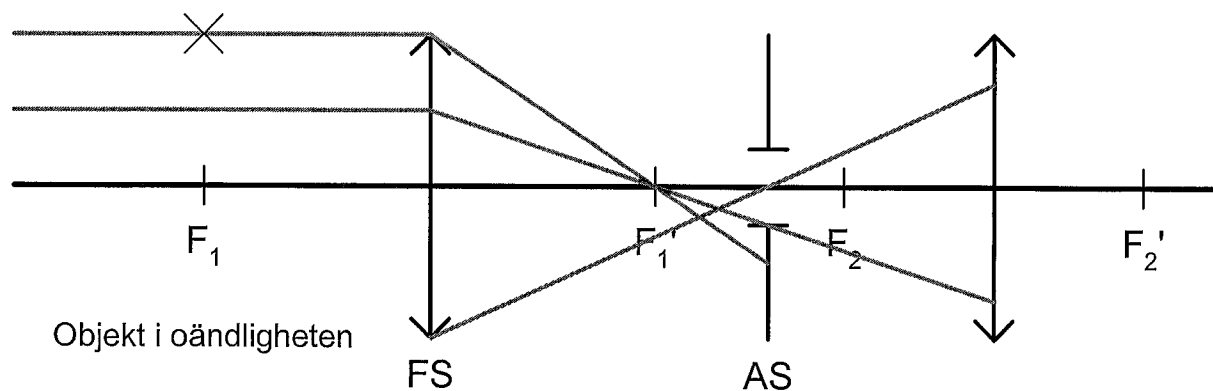
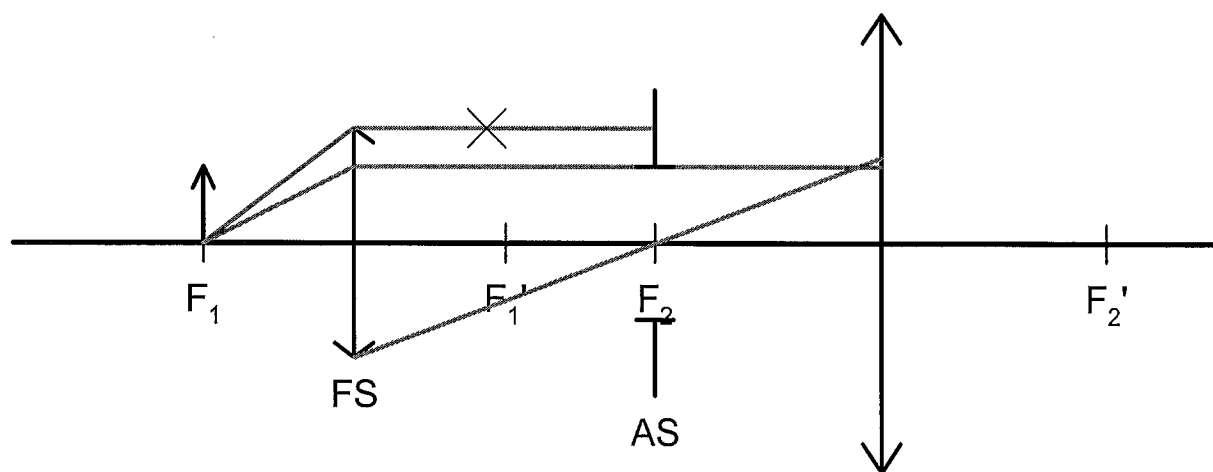
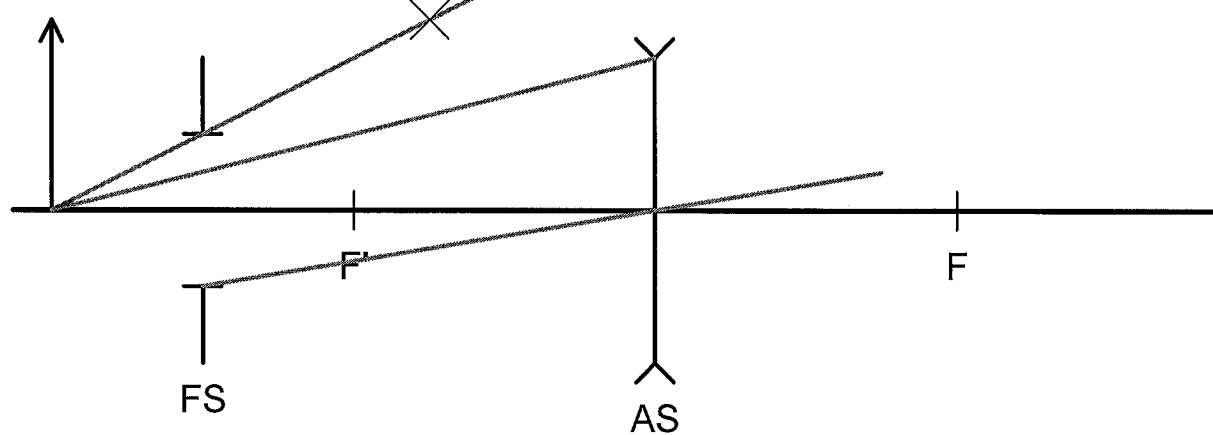
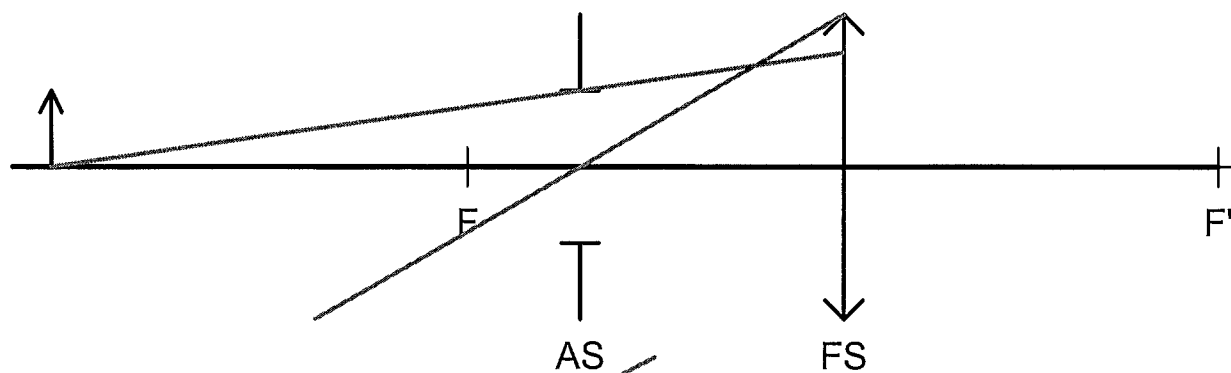

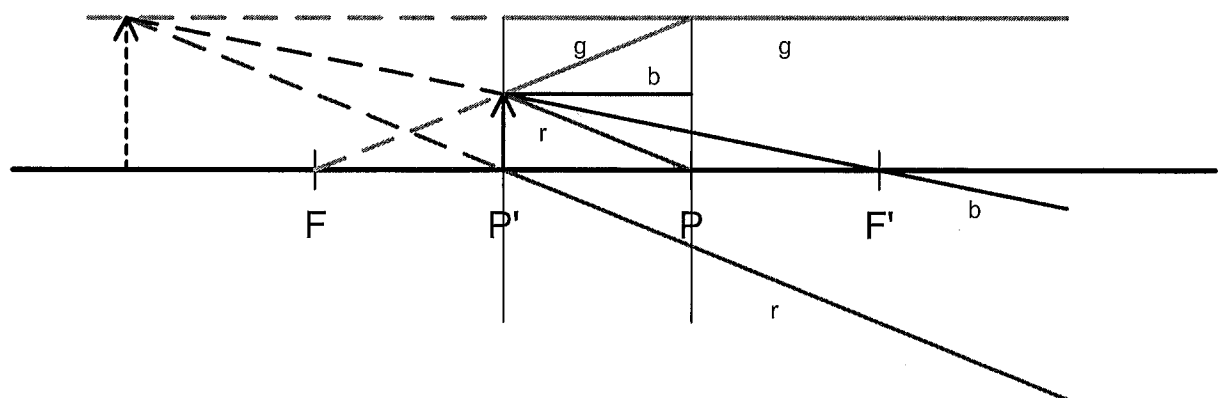
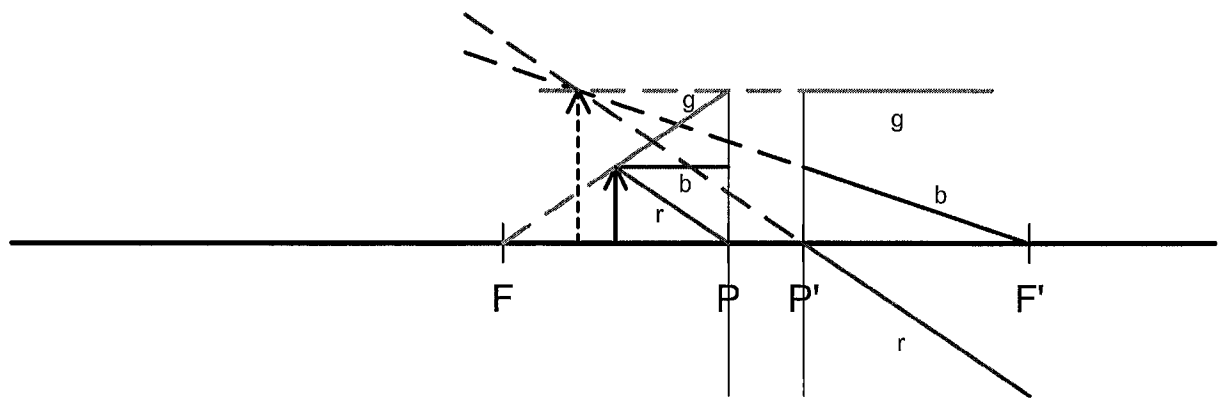
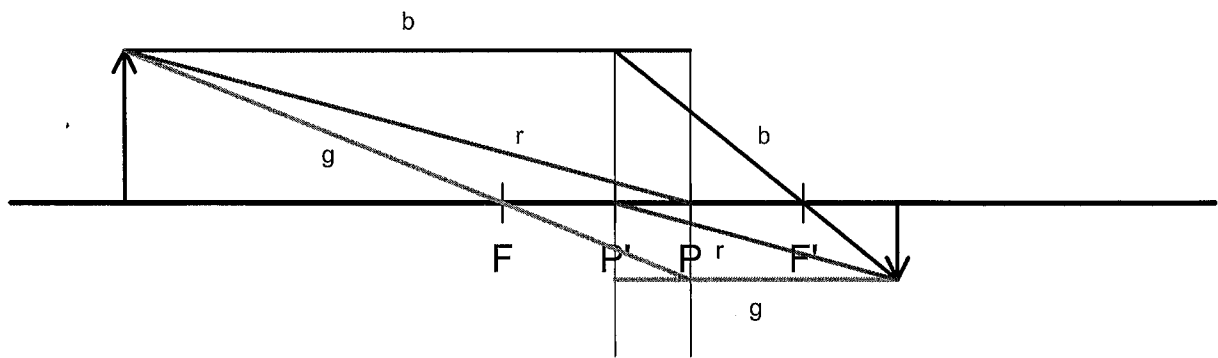
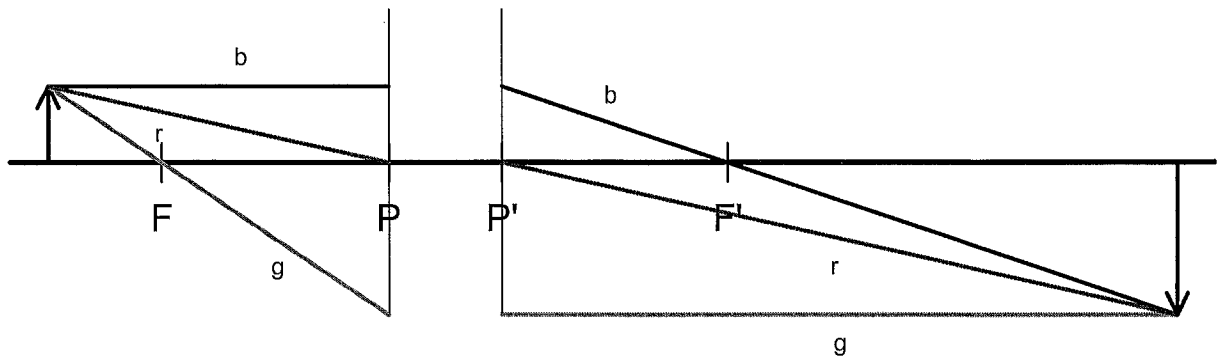



Rita in fortsatt strålgång. Använd hjälpstråle.

21'

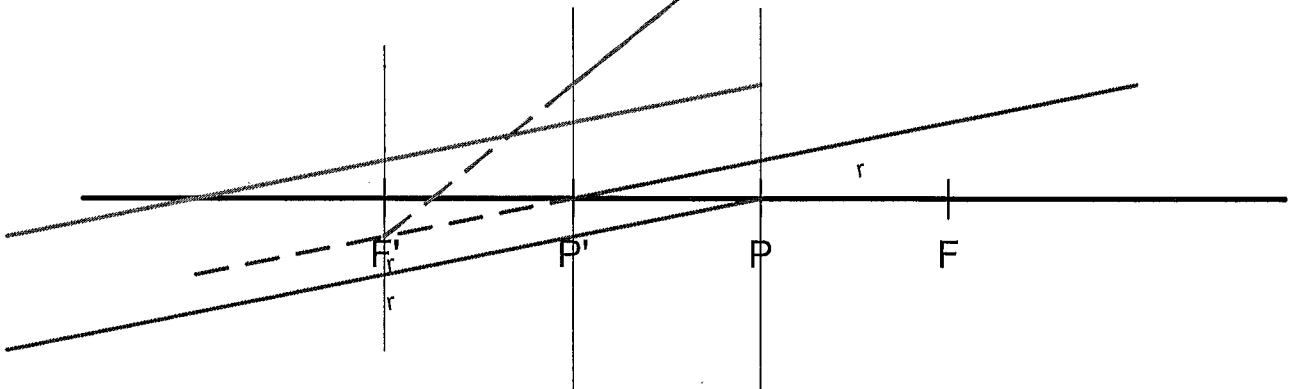
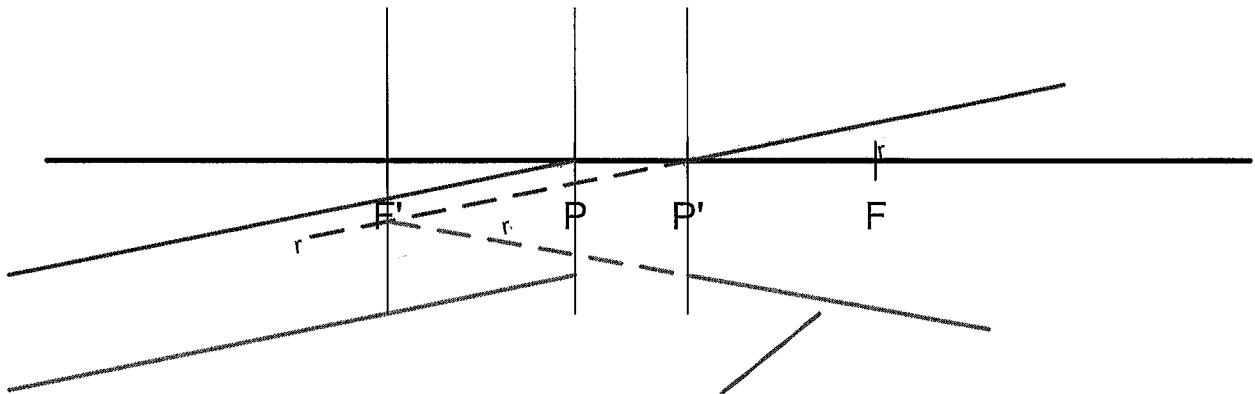
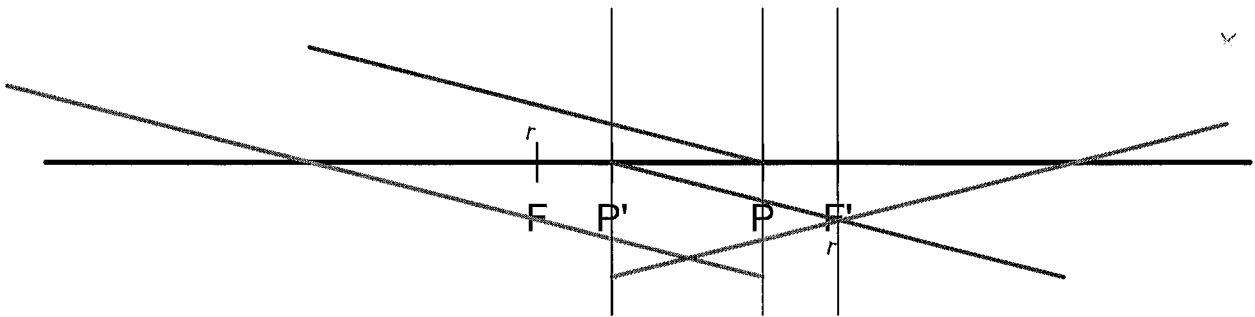
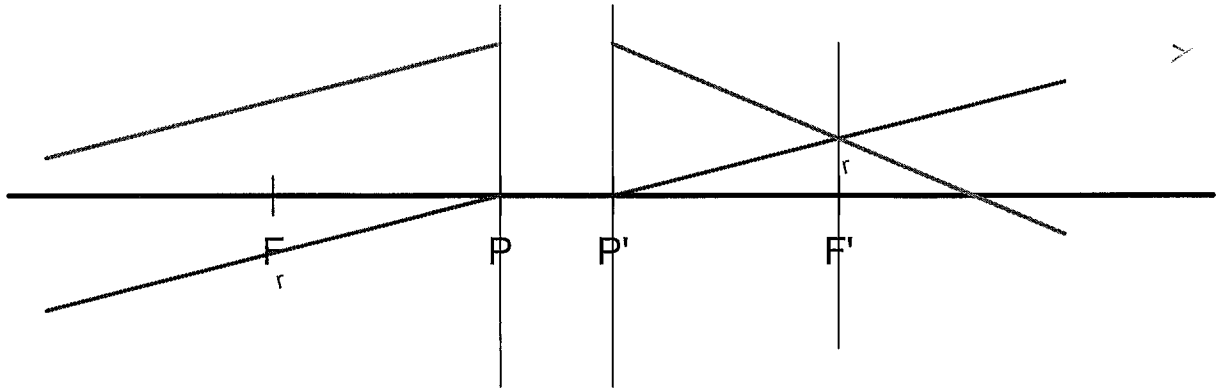

Hitta apertur och fältstopp för objekten.

22'

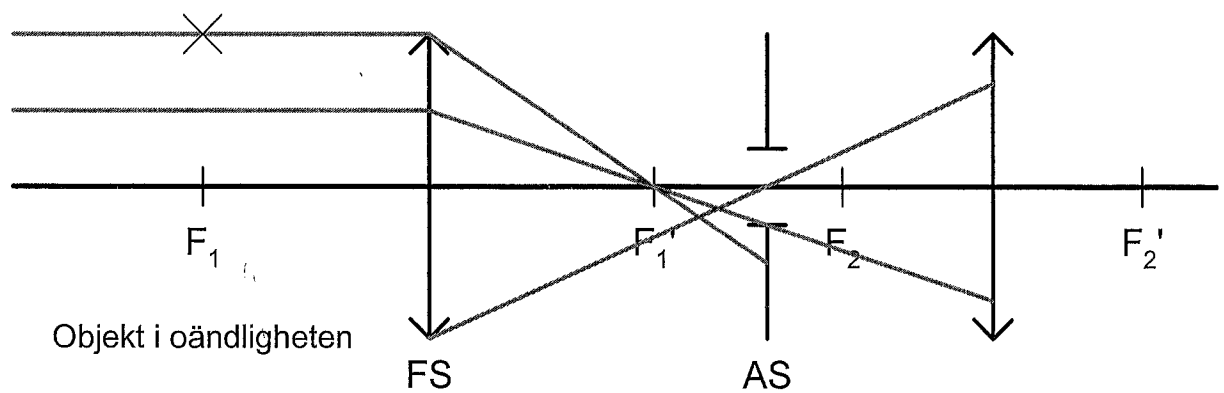
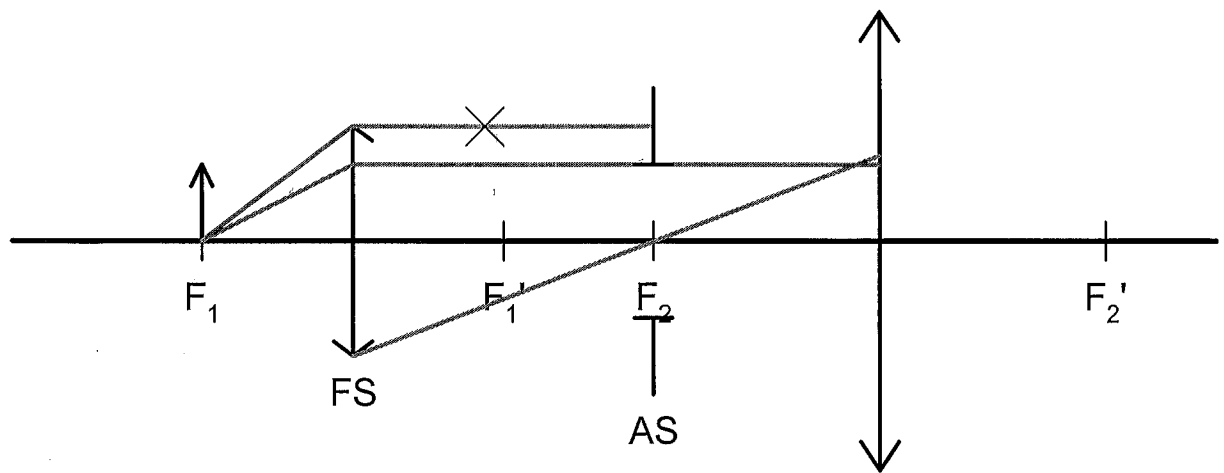
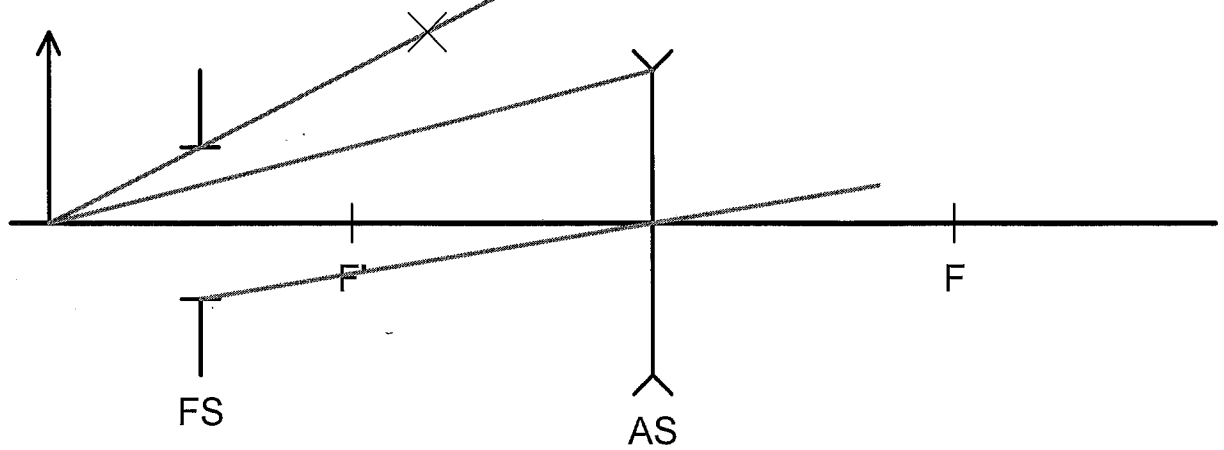
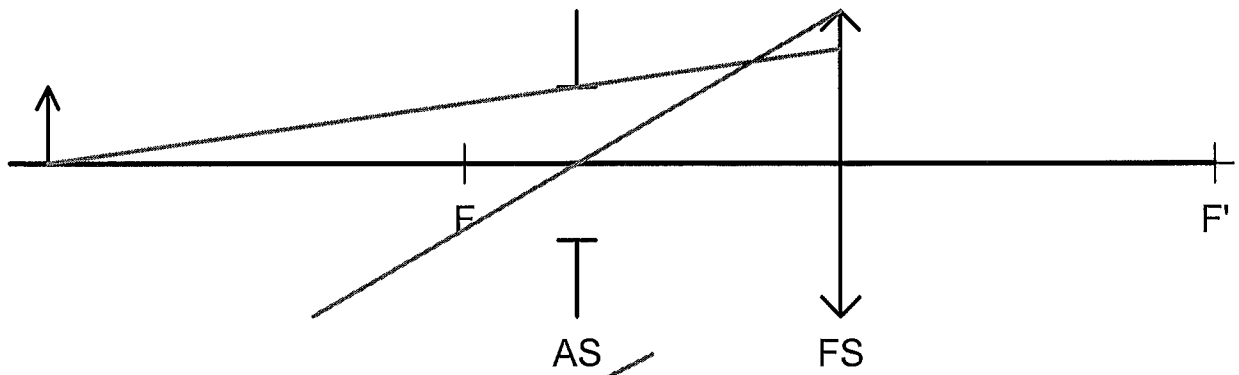

Hitta inträdespupill (IP) och utträdespupill (UP).

