



KTH ROYAL INSTITUTE
OF TECHNOLOGY

**KTH-A MAY 31 - JUNE 3:
*DIPLOMA DAYS***

www.arch.kth.se

twitter: @KTH_A

facebook: KTH Arkitektur

issuu: KTH Arkitekturskolan

youtube: KTH Arkitekturskolan

KTH Royal Institute of Technology

School of Architecture

Osquars backe 5, Stockholm

Designed by Björn Ehrlemark

Printed in Mölnlycke, Sweden, by Elanders AB in May 2016

**KTH-A MAY 31 - JUNE 3:
DIPLOMA DAYS**

<i>THE PRESENTATION AND EXHIBITION VENUES</i>	<i>2-3</i>
<i>THE JURY ON MAY 31 - JUNE 3</i>	<i>4-10</i>
<i>ARCHITECTURE DEGREE PROJECTS PRESENTED ON MAY 31 - JUNE 3</i>	<i>13-86</i>
<i>SUPD DEGREE PROJECTS PRESPRESENTED ON MAY 30-31</i>	<i>89-101</i>
<i>THE JURY ON JAN 12-13</i>	<i>104-105</i>
<i>ARCHITECTURE DEGREE PROJECTS PRESENTED ON JAN 12-13</i>	<i>107-117</i>
<i>KTH-A STUDIO THEMES 2015-2016</i>	<i>119-143</i>

**PRESENTATION & EXHIBITION VENUES:
KTH SCHOOL OF ARCHITECTURE
ON THE KTH CAMPUS**

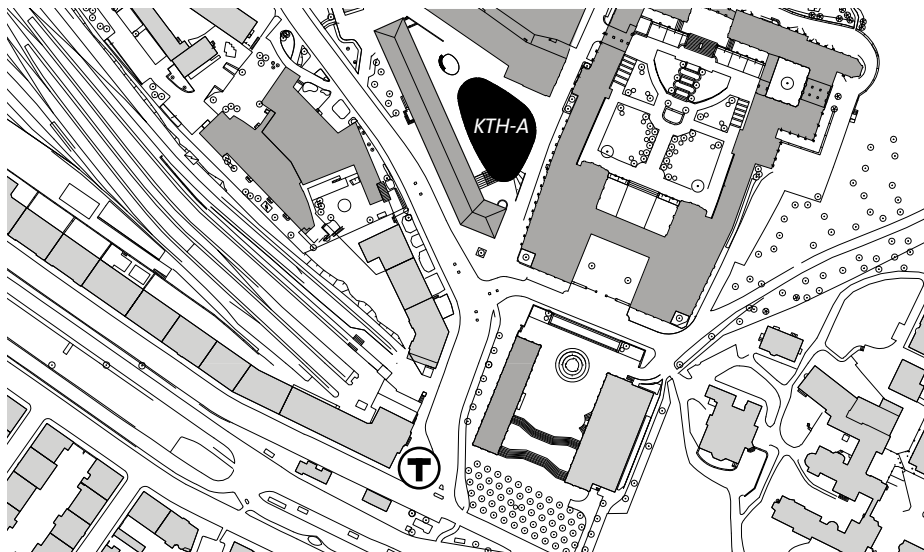

**EXHIBITION VENUES:
KTH ENTRÉ & KTH-A LEVEL 6**

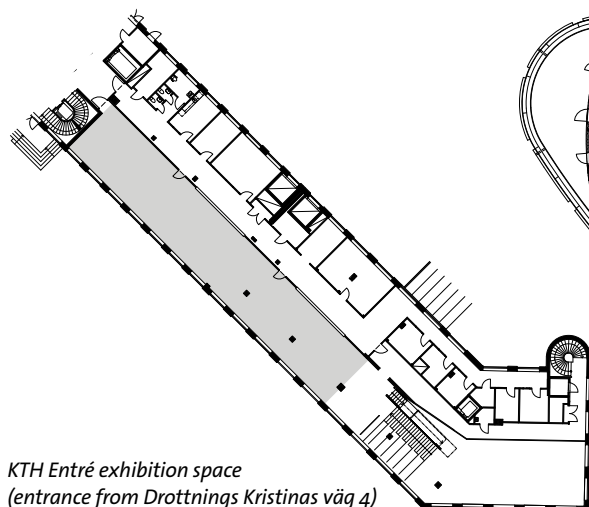

*KTH Entré exhibition space
(entrance from Drottning Kristinas väg 4)*

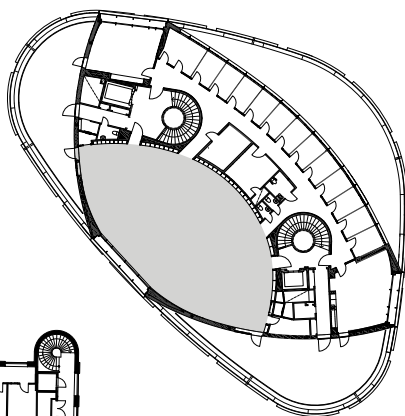

*KTH-A Level 6
(entrance from Osquars backe 5)*

**PRESENTATION & EXHIBITION VENUES:
ENTRANCE LEVEL ATELIERS**

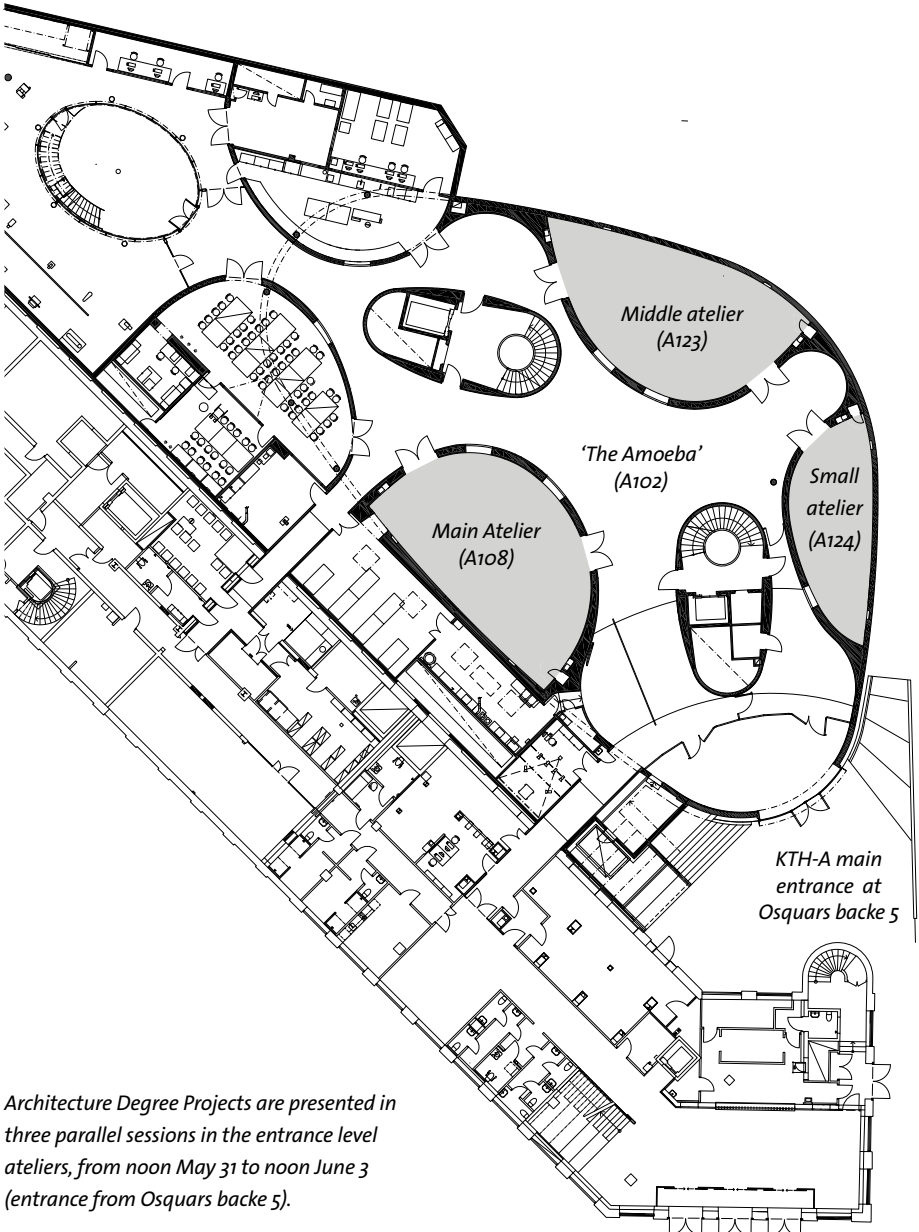

Architecture Degree Projects are presented in three parallel sessions in the entrance level ateliers, from noon May 31 to noon June 3 (entrance from Osquars backe 5).

THE JURY: **MAY 31 - JUNE 3**

ANTTI AHLAVA

Antti Ahlava (Helsinki, FI) is an architect and partner at helsinkizurich. He is full professor in Emergent Design Methodologies and leader of Group X at Aalto University and has been a visiting professor in Aarhus, Copenhagen and Vienna. He was recently a visiting fellow at Harvard GSD and head of the architecture department at Aalto University.

helsinkizurich has expertise in urban cultures and interdisciplinarity. It created international fame with smaller design projects such as Helsinki City Art Museum renovation and Hive nightclub and today works on larger scale urban developments in Finland, Central Europe and China.

Antti Ahlava's current projects include Aviapolis Centre at Helsinki Vantaa airport and the urban renewal of Espoo and Finnoo centres. Ahlava's earlier commissions include Munktelstaden housing development in Eskilstuna, Sweden, infill for the City of Helsinki and the urban design of Helsinki City Hall quarters.

Antti Ahlava won first prize in Andermatt city centre competition and in Espoo City Hospital competition (with K2S Architects) and second prize in Katara Hills competition in Qatar. He received a honorable mention in Helsinki Guggenheim competition. Ahlava's work was recently exhibited in Milan Design Week 2016.

CARLOS AROYO

Carlos Arroyo (Madrid, ES) is a Linguist, Architect and Urban Planner, and Researcher.

His Madrid-based office for Architecture and Urbanism has an international scope, with award-winning work in Spain, France, Belgium, Rwanda, Colombia and Argentina, developing protocols for innovation on all scales, from building technology to landscape management, creating new types of public building, or researching into new forms of housing.

Carlos Arroyo's projects have been exhibited in international venues like the Venice Biennale (8th and 14th) or the Institut Français d'Architecture, and featured in hundreds of international publications in Europe, Asia, Australia and the Americas.

He has taught and lectured in over 50 institutions and universities all over the world, including Tokyo University, New York's AIA, Princeton, Boston MIT, Berlin TU, Vienna AK, Milano, Paris, Bogotá, Sao Paulo or Buenos Aires. He currently runs a Master's Workshop at Universidad Europea de Madrid.

Carlos Arroyo is a Member of the European Scientific Committee since 2004, helping cities across Europe find the right strategy for their problem areas.

KATARINA BONNEVIER

Katarina Bonnevier (Stockholm, SE) is an architect, artist and researcher. In her practice of building design, art installations, performances, workshops, lecturing and writing she explores and transforms the built environment from feminist, queer and intersectional perspectives.

Recent work includes production design for the film *Flickan, mamman och demonerna* (2016), the interactive sculpture *Hitteblomster* (Bagarmossen, 2016), restaurant and hostel *Sankt Anna Gården* (2015), set and costume design for the theater *Unga Klara* (2014), and the *Fasad* program series for Swedish national radio (2013).

A founding member of the collaborative practice MYCKET with ongoing artistic research project *The Club Scene* (ArkDes, funded by the Swedish Research Council, 2014-17), *Luftslott* (inflatable pavilions and sewing circle, Norrtälje konsthall, 2016), and *Drömmarnas teater* (interactive exhibition, ArkDes, 2016).

A visiting professor at University College of Arts Craft and Design (2009-14), was a lecturer and researcher at School of Architecture (KTH), Stockholm (2001-2011), visiting professor at Haute Ecole Spécialisée de Suisse Occidentale (2010). Her writing includes *Behind Straight Curtains: towards a Queer Feminist Theory of Architecture* (PhD dissertation. 2007).

IÑAQUI CARNICERO

Active in both the academic field and a professional practice, Iñiqui Carnicero (Madrid, ES, & New York City, US) is an internationally awarded architect, European PhD and Professor at Cornell University. He is the director of the Spanish Pavilion for the 2016 Venice Architecture Biennale.

Iñiqui Carnicero has won several architecture competitions and completed many projects. His work has been recognized with awards such as AIANY Housing Award 2015, Design Vanguard Award 2012, Emerging Architecture Award Architectural Record 2011, Rome Prize 2009, FAD Spanish Architecture and Public Opinion Award 2012, and exhibited at the RIBA exhibition International Emerging Architects 2011, Architecture week in Prague, and GA Gallery Japan.

He has lectured at prestigious institutions such as Cornell, Harvard GSP, Rice, Berkeley, NJIT, Carleton, Roma Tre, La Sapienza, Calgary, Cervantes Institute in Prague, London Roca Gallery, Barcelona La Salle, Sevilla, Madrid ETSAM, and Navarra University.

He is the director of *Symmetries*, an architecture platform that relates Roman and contemporary strategies in the city. His Ph.D. dissertation focuses on Louis Kahn and Robert Venturi's discoveries and connections with Rome.

Since 2012 he runs the office Rica Studio with his partner Lorena del Rio.

DAGUR EGGERTSON

Dagur Eggertsson (Oslo, NO) is an architect with a professional background from a number of the most prominent offices in Oslo. After his professional degree from the Oslo School of Architecture in 1992, he started his collaboration with architect Vibeke Jenssen, as NOIS architects. In 1996 he finished a post-professional master's degree at the Helsinki University of Technology, where he started experimentation with building full scale architectural objects, under the supervision of Professor Juhani Pallasmaa.

Along with his professional practice, Dagur Eggertsson has taught architecture in Norway, Iceland, Sweden, Italy, Portugal, China, Australia and the United States. He is currently a John G. William Visiting Professor at the University of Arkansas Fay Jones School of Architecture and Design.

In 2007, Dagur Eggertsson started collaboration with architect Sami Rintala, which resulted in the foundation of the office Rintala Eggertsson Architects. The office is based in Oslo and Bodø, Norway.

LIZA FIOR

Liza Fior (London, UK) was born in London where she continues to practice as founding partner of muf architecture/art. muf adds unsolicited research to every project to expand incomplete briefs. The work of the practice negotiates between the built and social fabric, public and private in projects that have mainly been focused in East London but not exclusively so.

muf contributions to making public spaces, and making spaces public, include the interactive galleries of the Science Museum – working hard on where you can tread without a security pass within privately funded developments – and most recently exploring the museum as a shared public space at the V&A.

muf also has worked on Urban Strategies with the cities of Pittsburgh, Cologne and Gothenburg. Projects range from urban design schemes to small-scale temporary interventions via landscapes and buildings – a continual dialogue between detail and strategy. muf were the authors of the British Pavilion at the Venice Biennale in 2010.

Liza Fior has taught at Yale and the AA, and is currently external examiner at the Royal College of Art and contributes to the new MA and Dip Arch at Central St Martins.

MIA HÄGG

Founder of Habiter Autrement, Mia Hägg (Locarno, CH) has worked on some of the most innovative buildings and with some of the most respected architectural practices of the twenty-first century. In her early career she worked at Ateliers Jean Nouvel and Herzog & de Meuron, where she was Project Manager for the National Stadium of the 2008 Olympics in Beijing. She later became an Associate of the firm. In 2007, after nearly a decade working on mainly large-scale projects, she founded her own practice, Habiter Autrement.

Habiter Autrement has designed housing, stadiums, offices and masterplans. In Bordeaux, three award-winning public housing projects as well as a 100 metre long office building have been completed. In Paris, the office recently built 42 housing units as part of the renowned reconversion project *Entrepôt MacDonald*. Among other work, the office is currently working on an extension of the former KTH School of Architecture in Stockholm.

In the 2008 Venice Architecture Biennale, Mia Hägg and Jean Nouvel were invited to show their urban project for Slussen in Stockholm. For this year's Biennale, Mia Hägg has been given the opportunity to develop a marble project on the theme of the 2016 Biennale: *Resistance*.

SAM JACOB

Sam Jacob (London, UK) is principal of Sam Jacob Studio for architecture and design and was one of the co-founding directors of FAT Architecture. He has been responsible for a range of acclaimed projects ranging from the large scale – such as the master plan and design of the Heerlijkheid park and cultural centre in Rotterdam – to the cultural, including co-curating the British Pavilion at the 2014 Venice Biennale.

Sam Jacob is also a writer and critic, acting as contributing editor for *Icon* magazine and columnist for both *Art Review* and *Dezeen*. His book *Make It Real: Architecture as Enactment* is published by Strelka Press.

He is currently working on projects that include a masterplan for 250 homes, the reinvention of a business park and a mixed use development in London's Shoreditch.

Sam Jacob is Professor of Architecture at the University of Illinois at Chicago, visiting Professor at Yale School of Architecture and Director of Night School at the Architectural Association (AA) in London.

KAROLINA KEYZER

Karolina Keyzer (Stockholm, SE) is an architect and founder of the newly established architecture practice OKK+, Office Karolina Keyzer + Friends.

She was the City Architect of Stockholm between 2010-2015 – the 18th in a succession that began in 1661, and the first woman to hold the post. She was responsible for the new architecture guidelines for Stockholm, a policy document adopted in 2014.

She previously worked at Wingårdh Architects, where she was responsible for the Victoria Tower, one of the tallest buildings in Stockholm and winner of the hotel category at the World Architecture Festival (WAF) in 2012; and the Friends Arena Hotel in Solna, which received the city's 2013 Urban Environment Award.

Karolina Keyzer is a board member of Färgfabriken, a contemporary exhibition space in Stockholm devoted to art, architecture, and urban planning, and of the Birthe and Per Arvidssons Foundation, a nonprofit that supports the arts, architecture, and the humanities. She is also a member of the strategic council of the KTH School of Architecture. She is a frequent participant in national and international architecture juries, such as the Nobel Center competition in Stockholm, and the competition for a new Government Quarters in Oslo.

LESLEY LOKKO

Lesley Lokko (Johannesburg, ZA) is an architect, academic and the author of nine best-selling novels. She is currently Associate Professor and Head of School of the newly-formed Graduate School of Architecture at the University of Johannesburg, South Africa. Lokko studied at the Bartlett School of Architecture, University College London and gained her PhD in 2007 from the University of London. She has taught at schools of architecture in the US, the UK and South Africa. She is the editor of *White Papers, Black Marks: Race, Culture, Architecture* (University of Minnesota Press, 2000) and over the past decade, has been an on-going contributor to discourses around identity, race, African urbanism and the speculative nature of African architectural space and practice.

She is a regular juror at international competitions and symposia, and is a long-term contributor to BBC World and BBC Radio 3 arts programmes in the UK. In 2004, she made the successful transition from academic to novelist with the publication of her first novel, *Sundowners* (Orion 2004), a UK-Guardian top forty best-seller, and has since then followed with eight further best-sellers, which have been translated in fifteen languages.

ALI MALKAWI

Ali Malkawi (Cambridge, US) is Professor of Architectural Technology at Harvard GSD and an international scholar and expert in building simulation, energy conservation, and sustainability in buildings. He teaches architectural technology and computation and conducts research in the areas of computational simulation, building performance evaluation, and advanced visualization. He is also the founding director of the Harvard Center for Green Buildings and Cities, a multidisciplinary research institution that seeks to transform the building industry through a commitment to design-centric strategy that directly links research outcomes to the development of new processes, systems, and products.

Ali Malkawi serves as a consultant on many high-profile projects, including airport designs, super towers, industrial factories, cities, and commercial and residential showcase projects. He leads efforts in sustainability framework developments and provides strategic guidance and engages with energy policies in the U.S. and abroad.

He received his BS in architectural engineering and environmental design from Jordan University of Science and Technology in 1989, his MARCH from the University of Colorado in 1990, and his PhD in architectural technology/artificial intelligence from Georgia Institute of Technology in 1994.

LORENA DEL RIO

Lorena del Río (Madrid, ES & New York, US) is an architect educated at ETSAM (Escuela Técnica Superior de Arquitectura de Madrid), where she graduated in 2008 and is also developing her PhD. Her research concentrates on materiality in architecture and investigates new concepts related to the specific qualities of materials in design. From 2012 to 2016, she has been a Visiting Assistant Professor at Cornell where she has led design studios as well as seminars on Building Tech, Visual Representation and Architectural Theory. Lorena del Río has participated in reviews and lectures at several universities including MIT, Cooper Union, CCA, and Puerto Rico University where she also was a panelist at the symposium *Evolution of Pedagogy*. Beginning in fall 2016 she will be Assistant Professor at California College of the Arts in San Francisco.

Her work has been awarded internationally; recently in the competition to design new sport facilities at Dal-seong, Korea and European 12. It has also been widely published in international journals such as GA, Bauwelt and Arquitectura Viva. Together with Iñiqui Carnicero and as a result of their collaboration since 2009 Lorena del Río founded RICA* Studio in 2014, a platform for design investigation operating across many scales, based in Madrid and New York.

ANDREA SIMITCH

Andrea Simitch (Ithaca, US) is an Associate Professor with tenure at Cornell University where she served as the Director of the Bachelor of Architecture program from 2011 through 2014. She was also Associate Dean of the College of Architecture Art and Planning from 2002-03 and as Director of Undergraduate Studies from 2007-08. She has served as Visiting Professor at numerous institutions that include The University of Toronto, Rensselaer Polytechnic Institute, The University of Minnesota and Tunghai University in Taiwan and as guest critic at architectural institutions worldwide. She teaches courses in architectural design, architectural representation and furniture design and works by her students have been exhibited at the International Contemporary Furniture Fair in New York.

She is a partner with Val Warke in a collaborative architectural practice and recent works include residential and commercial projects in North America and in China, and competitions for the Arbedo Castione School in the Ticino, the Serbian Center for Science, and the Benetton Competition 'Designing in Teheran'. Her seminal book on architectural education, coauthored with Val Warke, entitled *The Language of Architecture, 26 Principles Every Architect Should Know* was published by Rockport Press in 2014 and has been translated into five languages.

MALIN ZIMM

Malin Zimm (Stockholm, SE) is an architect PhD, and currently employed as Research and Analysis Strategist at White arkitekter. Malin Zimm was engaged as Senior Advisor in Architecture at ArkDes (the Swedish Center for Architecture and Design) between 2010 and 2014. From 2007 until 2009, she was Editor-in-chief of the architecture magazine Rum.

Malin Zimm completed her doctorate studies at the KTH School of Architecture in 2005 with the thesis *Losing the Plot – Architecture and Narrativity in Fin-de-Siècle Media Cultures*, investigating pre-digital virtual architectures as found in literature and early cinema from late 19th Century. Zimm is a contributor to Swedish and international architecture magazines and publications since 1999, most recently with an essay about fan fiction and fan culture in relation to architecture, in *Breaking and Entering – The Contemporary House Cut, Spliced, & Haunted* (ed. Bridget Elliott, McGill-Queen's University press, 2015).

Malin Zimm's research interests include the development of the subject of architecture in relation to society, culture, technology and media.

Sessions are held in Swedish and English, with Jury Host from the KTH-A faculty.

**ARCHITECTURE DEGREE PROJECTS:
PRESENTED MAY 31 - JUNE 3**

Architecture Degree Projects by:

JOHAN AHL ELIASSON
MALIN AHLGREN BERGMAN
KRISTINA BARNIŠKYTĚ
LI BIAO
MÅNS BJÖRNSKÄR
ANTON BOGÅRDH
KRISTOFFER DAHL
NATALIA DAUKSZEWICZ
INESE DINDONE
STEFANIA DINEA
ULF EDGREN
OSKAR EDSTRÖM
NOA ERICSON
HANNES ERIKSSON
MARTIN ERIKSSON
DANIEL FLIMEL
MATTIAS FLOXNER
ARVID FORSBERG
MARIA FORSMAN
FELIPE FRANCO
MARIA GLASSEL
ALEXEY GOLITSYN
LEONIE GREINER
HILDUR GUÐMUNDSDÓTTIR
MIKAEL HASSEL
ARON HEINEMANN
ALVA HULT
LOUISE HUSMAN
JOHANNA JACOBSON
EIRA JACOBSSON
ARVID JANSSON
GABRIEL JOHANNESON
GABRIEL JONSSON NORDBÄCK
MARIA KARAMANOU
ANNA-MI KARLSUDD
JAKUB KOLEC
MÅRTEN KYRKLUND
MADELENE LARSSON

TOBIAS LIDMAN & GUSTAV SVÄRDH
ISABELLE LINDBLAD
VALTER LINDGREN
DAVID LINDMARK
JOHAN LINGMARK
FELIX LOTZ
EMILIA LYONS
LISA MELIN MAHFOUZ
JESPER MELLGREN
PAVEL MUSAMBA
EMILIE NÄSLUND
JOHAN NILSSON
EVA NYBERG
BENJAMIN ONOSZKO
LISA PALM
FRANCESCA PERNIGOTTI
JACK PHIPPS
HILLEVI ROBERTSSON QUINN
ANNA RODIN
ANDERS STENHOLM
HJALMAR STENLUND
FRIDA STJERNQVIST
KAMELIYA STOYANOVA
LOVA STRINDBERG
JOHANNES SVERLANDER
BEATRIZ DE UÑA BÓVEDA
JAKOB VALENTIN
JOAKIM WADENHOLT
GUSTAV WALLERIUS
LOVISA WALLGREN
ANNA WEGLIN ELENIUS
RASMUS WESTMAN
FANNY WETTERROT
JOEL YNGVESSON
TIANLE YU
DANIEL ZETTERBERG
OSKAR ÅSTRÖM
RAKEL ÖSTLUND



**JOHAN AHL ELIASSON:
PROJECTING REALITIES
– *REMEDICATION IN THE REALM OF ARCHITECTURE***

The boundaries between physical and virtual are dissolving as worlds are super-imposed. The design proposal of a movie theater at S:t Eriksgatan in Stockholm acts as a vehicle for exploring the opportunities of architecture in an unstable reality. By regarding architecture as a world-conjuring operation, parallel investigations into other media provide new tools of design. How can the traits of an image or diorama inform architecture?

Studio 7, supervised by:
ELIZABETH HATZ
PETER LYNCH

Contact details:
issuu.com/johanahleliasson
johanahleliasson@gmail.com



MALIN AHLGREN BERGMAN:
FRUÄNGEN CENTRUM
– A CONTEXTUAL APPROACH TO PUBLIC SPACE

The suburban commercial centre appeared as a new phenomenon in Swedish post-war planning. Characterised by separation of both uses and traffic, it conflicts with contemporary planning ideals. Today, post-war suburbs are subject to significant gentrification and densification, which has social and architectural consequences. This project explores methods of intervening spatially in such post-war centres while not contradicting the inherent logic of its system.

Studio 2, supervised by:
TOR LINDSTRAND
ANDERS WILHELMSON

Contact details:
ahlgrenbergman.se
malin@ahlgrenbergman.se



KRISTINA BARNIŠKYTĖ:
A FICTION IN WOOD AND CONCRETE

The School of Architecture building was finished in 2015. Round concrete cores were cast and wood cladding was nailed board by board. Materials reigned inside the empty building. Sand grains in concrete were bubbling, mixing with cement powder and water, while wood fibers were shaking nervously, trying to grow higher and poke through the ceiling.

In architectural discourse, form is usually designed first, then a material is chosen to build the volume with. However, can *materials' surfaces* at micro-scale become generators of form and structure? I have explored this through a full scale installation, built in wood and concrete.

Studio 5, supervised by:
ULRIKA KARLSSON
EINAR RODHE

Contact details:
kristina.barniskyte@gmail.com



**MÅNS BJÖRNSKÄR:
FRAGILE CONTINUITIES
– *MAKE BELIEVE OPERATIONS IN VILLA STUREGÅRDEN***

Sturegården was designed in 1913 by a young E.G. Asplund. The villa harbours a sense of being in a tradition and implementing references into a new context. Tradition could be considered a system that organises and maintains a sense of historicity, context and coherence. It is a matter of continuity, based on memory, common sense, and experience.

My project focuses on subtle alterations and additions to the villa, speculative or necessary, with a clear sensitivity to architectural form and continuity.

Studio 3, supervised by:
JOSEF EDER

Contact details:
mans.bjornskar@gmail.com

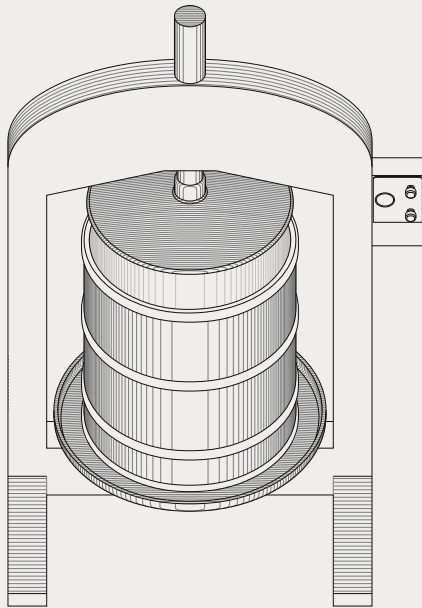

**ANTON BOGÅRDH:
VINEYARD, ÖLAND**

The aim of the thesis project has been to form a vineyard located in the northern Öland, a new type of agriculture that has been expanded since the millennium on the island. Parallel with a profound investigation of the historical tradition on the island and the use of the local material limestone and placing a building in the distinctive context.

Studio 3, supervised by:
CARMEN IZQUIERDO

Contact details:
anton.bogardh@gmail.com

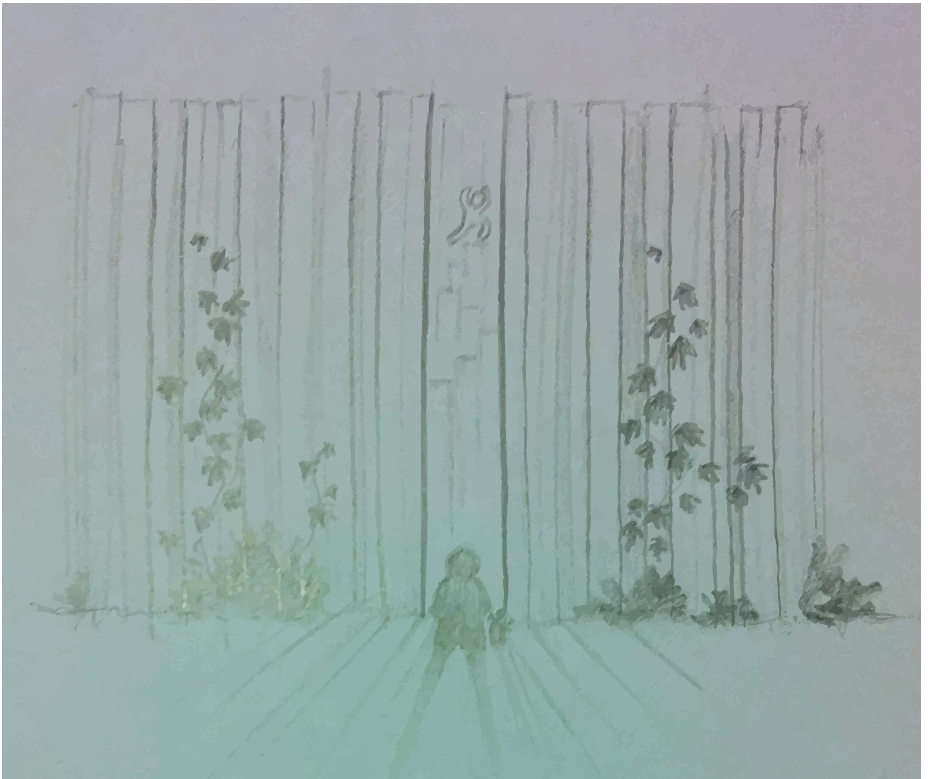

KRISTOFFER DAHL:
FINDING THE PLAYGROUND'S LOST SOUL

I remember when I was eight years old and we moved from one part of town to another. The same school, the same friends, but a different playground. It had the longest slide i'd ever seen, two home built jungle gyms and a tractor tyre swing. It wasn't well kept or well lit, but it was a very special place. It was OUR place. In the mass-produced playgrounds of today I feel like that magic is lost. There is no mystique, no soul. In this project I wanted to find the playground's lost soul.

Studio 1, supervised by:
EBBA HALLIN
JOHAN PAJU

Contact details:
kristofferdahl@hotmail.com

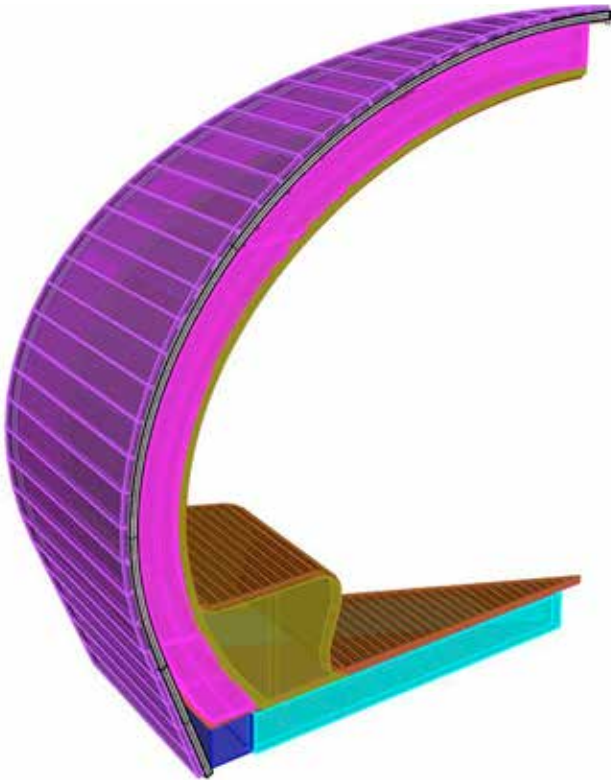

NATALIA DAUKSZEWICZ:
SVENSK BASTU 4.0

The building construction field slowly starts taking part in the Industry 4.0. The software development among the market participants makes the building process more advanced. We observe increased influence of large construction companies and the developers on the building market, by using the prefabricated elements. At the same time, architects seem to lose their impact in the field. Is it because of their lacking knowledge? Can we deploy our education in a commercial way under existing regulations?

Studio 9, supervised by:
KAYROKH MOATTAR
JONAS RUNBERGER
JULIEN DE SMEDT
ELSA WIFSTRAND

Contact details:
ndaukszewicz@gmx.at



**BEATRIZ DE UÑA BÓVEDA:
*ENTROPIA – A TALE FROM THE NORTH***

A fairy tale. A story. Infinite stories. About people from here, people from there. About movement. In and out. A journey. From the desert to the woods. New nomads and their vanished land. About displacement and crossing frontiers. Lost traditions. Towards depopulation and old factories. Memory and nostalgia. Miscellaneous cultures. How chaos and order meet. How to build the void. How a town builds itself. The performance will take place in Bergslagen. A region in a state of entropy.

Studio 4, supervised by:
CHARLIE GULLSTRÖM
ORI MEROM

Contact details:
beadeub@gmail.com



INESE DINDONE: *RESURRECTION*

On the coast of the Baltic sea, a forgotten naval port stands guard in solitude, ample with scars from battling the passage of time. Only abandoned remnants remain, a shadow of its former busy life in service to the Russian Tsar monarchy, a strategic asset stationing nearly 30,000 soldier and their family. A study of seeding life and rejuvenation of an area and its inhabitants. In today's fascination with the "new" and "advanced", how we reestablish purpose and life to century old architecture.

Studio 6, supervised by:
LEIF BRODERSEN
TERES SELBERG
CHRISTIN SVENSSON

Contact details:
dindone.inese@gmail.com



STEFANIA DINEA: *ARCHITECTURE.FORM.ENERGY*

The project seeks to identify design choices (i.e. location, climate factors, volumetric, etc.) that affect the energy consumption of buildings, with a focus on mixed-use development. This can be achieved by introducing a simplified energy consumption calculation method, developed with the help of parametric design. The project includes analysis on shape and functions in relation to energy consumption, and the research methodology with an application on the Albano Campus site.

Studio g, supervised by:
 KAYROKH MOATTAR
 JONAS RUNBERGER
 JULIEN DE SMEDT
 ELSA WIFSTRAND

Contact details:
www.dinea.design
smdinea@gmail.com

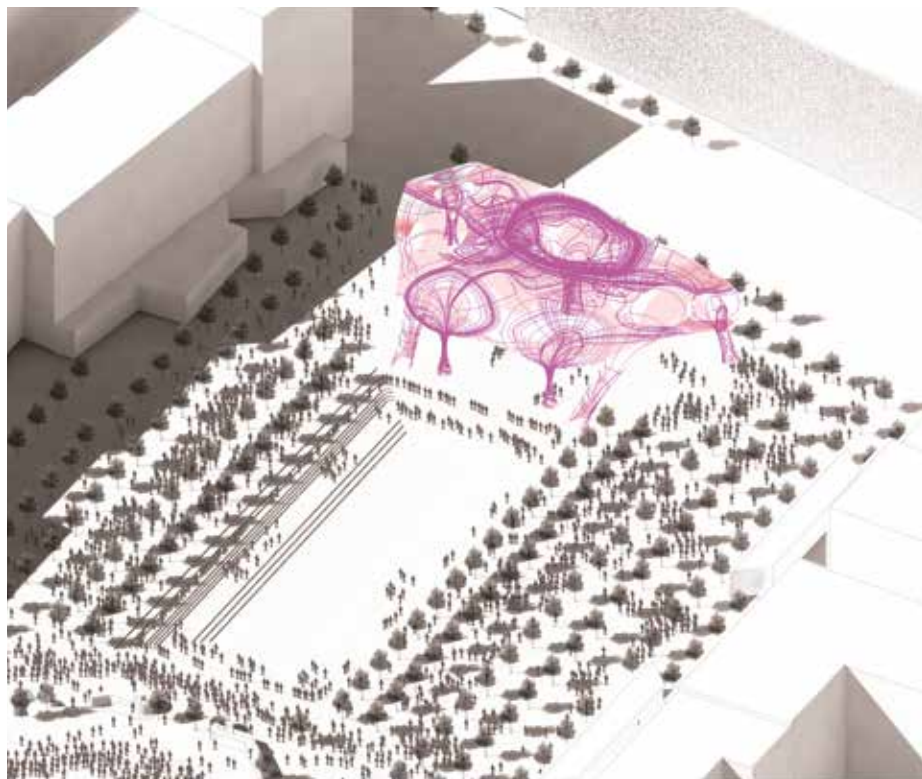

ULF EDGREN:
STRUCTURALLY INFORMED DIGITAL DESIGN

How can integrated structural feedback inform the architect during the early design process? The architectural possibilities and pitfalls of using structural analysis and structural concepts as design parameters are investigated by creating a structurally aware parametric model in collaboration with two engineering students.

Parallell to the thesis project, during the spring of 2016, Apple has made quick progress in their negotiations for a new flagship store at Kungsträdgården's north end in Stockholm, a site the company acquired in the summer of 2015.

With the help of the parametric model, a counterproposal in the form of a public structure has been developed on the very same site, suggesting a different approach to the treatment of this key location in Stockholm.

Studio 9, supervised by:
KAYROKH MOATTAR
JONAS RUNBERGER
JULIEN DE SMEDT
ELSA WIFSTRAND

Contact details:
ulfedg@gmail.com



OSKAR EDSTRÖM:
ALL THE WORLD'S A STAGE
– A TRANSIENT THEATRE OF EVERYDAY LIFE

The City has by some fluke forgotten to assimilate a spot into its weave. This we must accentuate. Form a place of intensity, a theater with the transient aspect of the Art at its core. The fundamentals, eternal. An infrastructure or Ruin if you like. Upon a construct springs, allowing passage, up around, into. A Beast of wood and steel. Seasonally it Blooms, the spectacle begins. A garden of sorts, but also a stage from where we will not solely see our lives reflect but more so have them transpire.

Studio 7, supervised by:
ELIZABETH HATZ
PETER LYNCH

Contact details:
oskar.edstrom@gmail.com

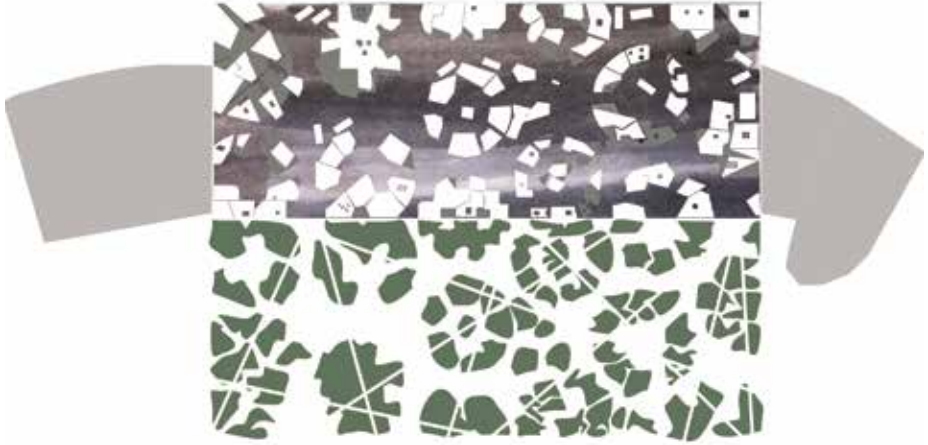

NOA ERICSON:
AN URBAN SPACE COLONY
– RETROFITTING A DOOMED TYPOLOGY

Society is collapsing. The shift from a consumer oriented material world into a resource/service based economy is evident.

What do we do with the ruins of a consumer based society?

Bromma blocks is a shopping centre within an industrial urban area. The project aims at creating a community driven city plan within a retrofitted structure. Shifting the role of the architect and dweller towards a new urban life.

Studio 4, supervised by:
CHARLIE GULLSTRÖM
ORI MEROM

Contact details:
namshubben@gmail.com



HANNES ERIKSSON:
ONE + ONE > TWO

In view of the large housing crisis in Sweden, numerous voices have been raised offering solutions; make the current housing stock more available, reduce apartment sizes, abolish noise restrictions for new housing projects, etc. What's lost in this pragmatic approach is one fundamental question: how do we want to live?

This thesis project questions the normative ideals of dwelling and tries to widen the scope of how we can live.

Studio 2, supervised by:
TOR LINDSTRAND
ANDERS WILHELMSON

Contact details:
eriksson.hannes@gmail.com



MARTIN ERIKSSON:
TERRACED HOUSES SVINDERSVIKEN

The steep ridge running through the south of Stockholm gives the city a unique identity. In central parts you will find streets with buildings on one side and a rock wall on the other.

My project is located along this precipice just outside of the city centre in the municipality of Nacka. I have used the ridge to organize sixty terraced houses north of Svindersviken.

Studio 2, supervised by:
TOR LINDSTRAND
ANDERS WILHELMSON

Contact details:
martin@zut.se

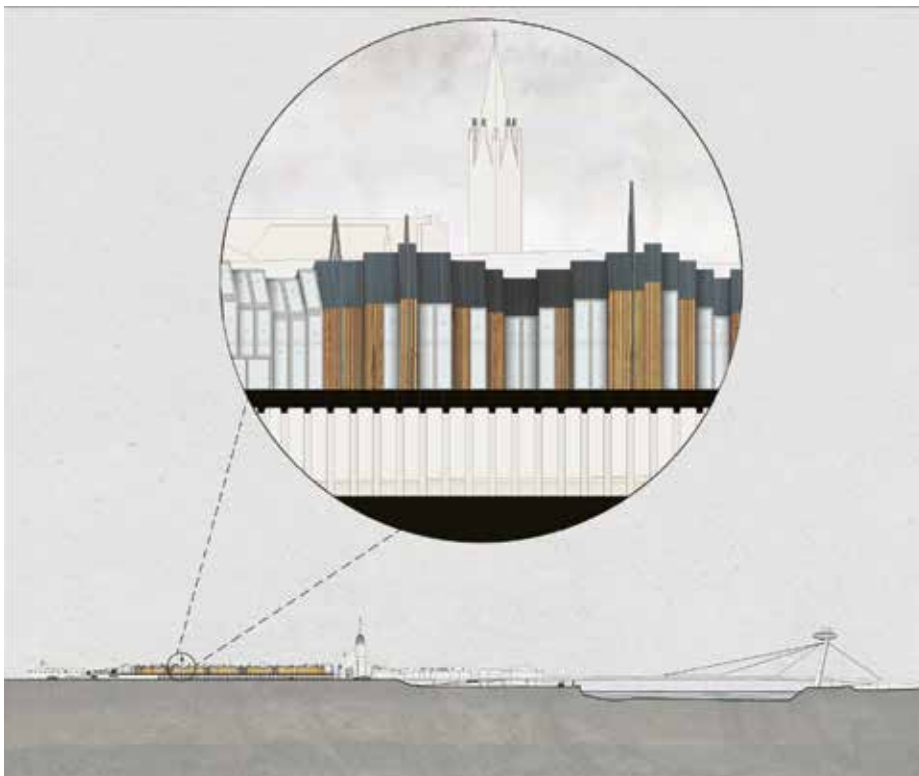

**DANIEL FLIMEL:
*HEALING THE FURROW***

Almost thirty years have passed since the Velvet revolution in Czechoslovakia. How should we architecturally reflect upon actions that took place during the era of normalization*?

This project explores a furrow stretching through the old town of Bratislava, excavated during the construction of the Bridge of Slovak National Uprising. A new architectural structure reintroduces the forgotten context of the city by merging essential values which have disappeared along the way.

** a term commonly given to period 1969-87 in Czechoslovakia, characterized by firm ruling position of the Comunist Party and subsequent preservation of this status quo.*

Studio 4, supervised by:
CHARLIE GULLSTRÖM
ORI MEROM

Contact details:
daniel.flimel@gmail.com



MATTIAS FLOXNER:
BUILDING BEHAVIOR

Architecture not only reflect the attitudes of the people by and for whom they were made, they also actively shape human behavior.

The physical layout of a situation has been considered important through the ages for all ceremonial occasions. It not only influences the behavior of the participants, it also defines their social status.

Studio 6, supervised by:
LEIF BRODERSEN
TERES SELBERG
CHRISTIN SVENSSON

Contact details:
mattiasfloxner@gmail.com

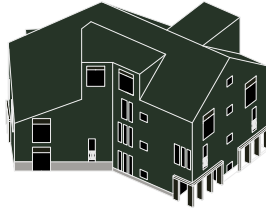
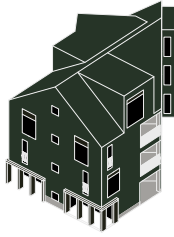

**ARVID FORSBERG:
GAMLA ENSKEDE E MANIERA**

Gamla Enskede is commonly known as the first garden city in Sweden. The thesis suggests ways of making new dwellings in this hermetic context, while celebrating the seemingly accidental and loose character of the garden city plan. Calling upon the formal logics of mannerist architecture, I propose an architecture that is defined at once by its proclivity towards adjustment and the indifference of its formality, where the city becomes a motif for the building that takes place within it.

Studio 3, supervised by:
CARMEN IZQUIERDO

Contact details:
forsberg.arvid@gmail.com



**MARIA FORSMAN:
*WATER AND URBAN SPACE***

Gothenburg emerged because of the river, but the river has become a barrier, preventing urban development. This thesis proposes a series of connections, including a public bath. The goal is to support physical and social urban functions, and develop the city on different scales. The public bath contains a floating building which purifies the water. The bath becomes a link between north-south and land-river, enabling cultural and ecological dynamics, while turning the basin into a swimming pool.

Studio 8, supervised by:
SARA GRAHN
RUMI KUBOKAVA

Contact details:
mariaforsm@gmail.com

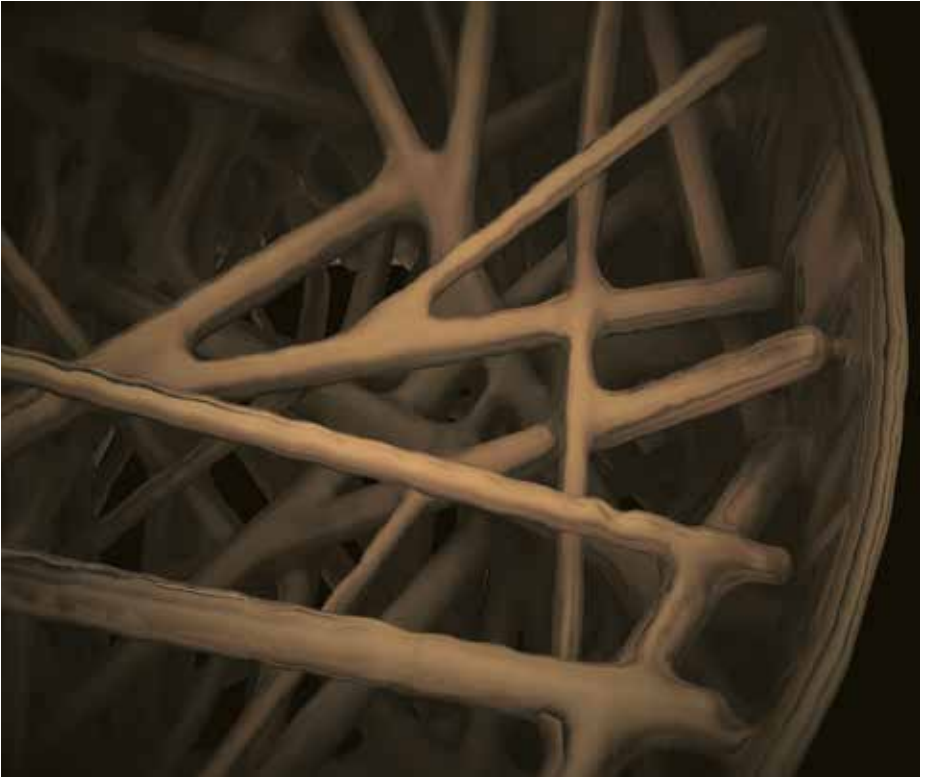

FELIPE FRANCO:
WITHIN

The continuous development of novel fabrication processes, such as 3D Printing and other Additive Manufacturing (AM) techniques, will lead to unprecedented transformations in industry and architecture.

WITHIN is a Thesis work driven by the exploration of the possibilities of AM at an architectural scale, combined with the use of a cellulose-based material, obtained from sustainable sources. The chosen program is a medium scale recreational facility located in Stockholm's waterfront.

Studio g, supervised by:
KAYROKH MOATTAR
JONAS RUNBERGER
JULIEN DE SMEDT
ELSA WIFSTRAND

Contact details:
felipefranco8610@gmail.com



MARIA GLASSEL:
THE CABINET HOUSE

This project is based upon a fascination and study of 17:th century cabinets and exploration of it's intricate content and structure. By using the cabinet and its qualities as a basis, the project is an investigation how a residence could be experienced in a similar way; as an exploration through drawers, shutters and compartments but instead be about space and how we experience it.

Studio 6, supervised by:
LEIF BRODERSEN
TERES SELBERG
CHRISTIN SVENSSON

Contact details:
maria@mariaglassel.se

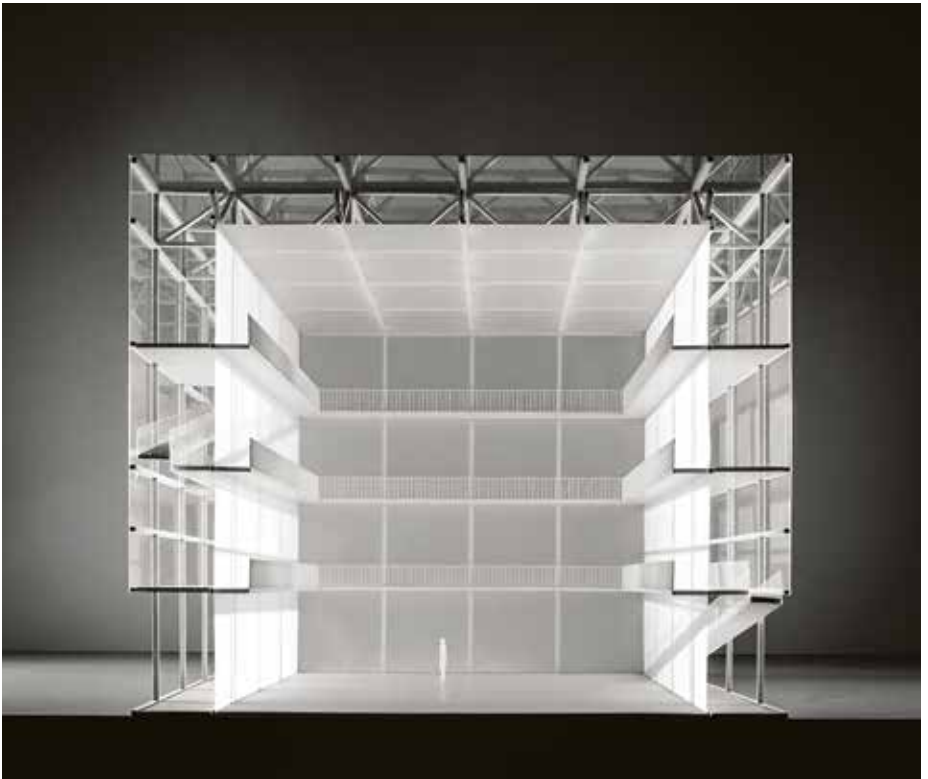

**ALEXEY GOLITSYN:
*DESIGN MUSEUM ON SKEPPSHOLMEN ISLAND***

This work started with the analysis of cultural politics in Sweden within fields of architecture and design by using the example of ArkDes, which was under the threat of closing down. It resulted in a proposal for a Design Museum, addressing the ability and need of a museum to reshape and rediscover itself. Defining an abstract museum room through comparison with a traditional gallery space, a shift from an object oriented exhibition towards representation, experiment and performance was suggested.

Studio 2, supervised by:
TOR LINDSTRAND
ANDERS WILHELMSON

Contact details:
alexgolitsyn@gmail.com

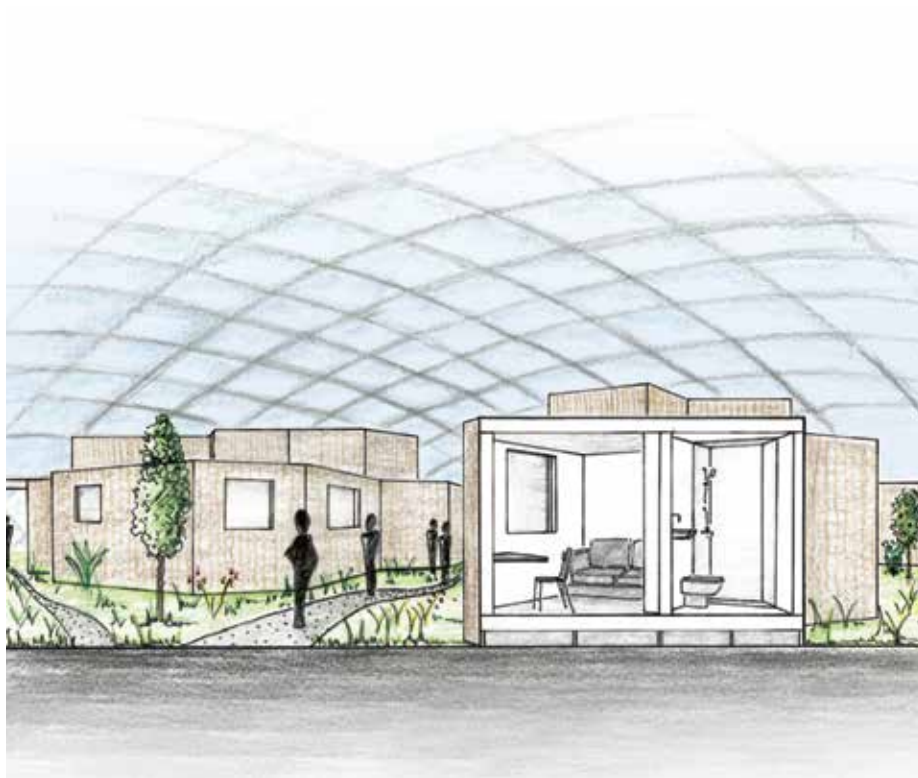

LEONIE GREINER:

FINDING COMMON GROUND – REFUGEE HOUSING IN STOCKHOLM

This project investigates how architecture can influence society's perception of refugees. The site in Fagersjö was suggested for refugee housing by the city. This raised questions and even resentment by the local population. My project proposes to incorporate a concept that benefits the community and raises acceptance. In temporary housing aesthetic, economic and especially social issues arise. The design aims to resolve these, creating a place that allows living with dignity and links locals and refugees.

Studio 9, supervised by:

KAYROKH MOATTAR
JONAS RUNBERGER
JULIEN DE SMEDT
ELSA WIFSTRAND



HILDUR GUÐMUNDSDÓTTIR: *DESIGNING FOR ICELANDIC WEATHER CONDITIONS*

Icelandic inhabitants have throughout history fought a battle of survival with extreme force of weather. The Island provides hardly any protection against wind due to its location in the middle of the Atlantic Ocean and lack of vegetation. The most powerful tool that we possess to limit the effect of weather is the built environment. This project will demonstrate how forms and shapes of buildings and built environment can be used to create shelters and improve outdoor life.

Studio 6, supervised by:
LEIF BRODERSEN
TERES SELBERG
CHRISTIN SVENSSON

Contact details:
hilgud@gmail.com

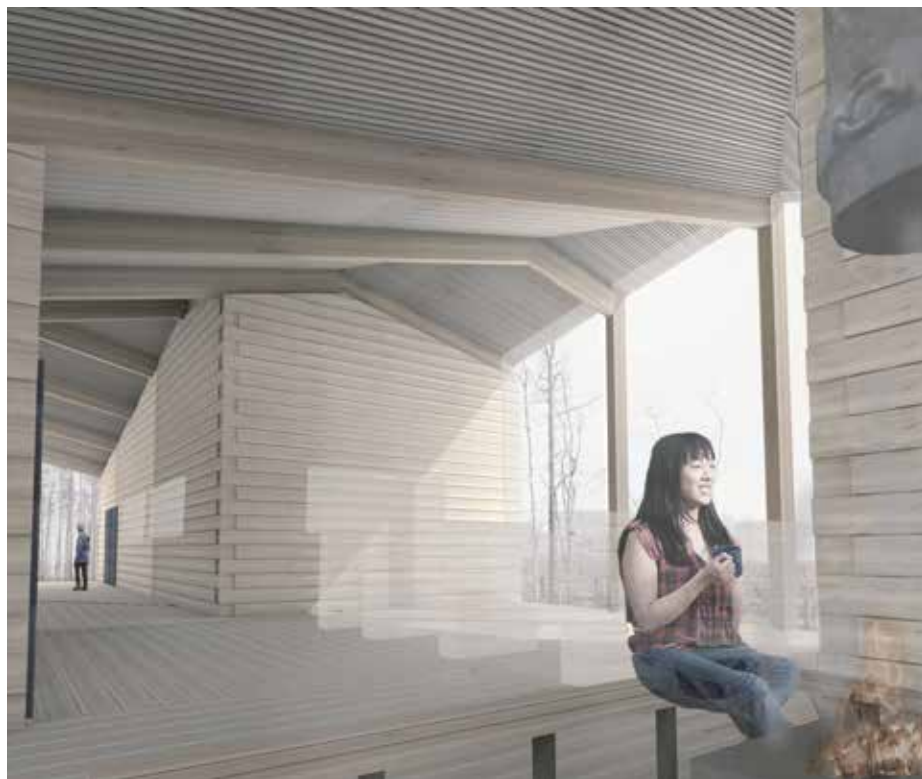

MIKAEL HASSEL:
NATURUM & ECOTURISM CENTER
– I NYBILDAT, BRANDHÄRJAT NATURRESERVAT

A hub for eco- and fire tourism in the heart of the big fire of 2014 in Västmanland. The project aims to deal with the change that is taking place in the new Nature reserve Hälleskogsbrännan. Starting in vernacular architecture it is exploring building and constructing with wood. The project is interplay between enclosed volumes and open space. It also aims to activate the whole nature reserve with small incisions and at the same time bring a new start to the countryside as a whole.

Studio 3, supervised by:
CARMEN IZQUIERDO

Contact details:
hassel.mikael@gmail.com



ARON HEINEMANN:
LET'S TALK ABOUT THE SCHOOL OF ARCHITECTURE!
– A DOCUMENTARY ON DIVERSIFICATION IN THE KTH-A

'Our challenge must be to go beyond architecture and speak the languages of these other disciplines ...] architects have a responsibility to engage in broad conversations [...] Our ultimate focus is still on form, but what informs this has expanded dramatically.'

– Alejandro Aravena, *The Guardian*, Nov 20 2015

I wanted to propose a discussion on the responsibility of the architect. I thought that the changing demands on us really is a pedagogic challenge. If we are to expand our role we actually have to diversify ourselves. I wanted us to talk about diversification in our trade and it should start with our own school.

Studio 2, supervised by:
TOR LINDSTRAND
ANDERS WILHELMSON

Contact details:
aronheinemann.se
aronheinemann@gmail.com



ALVA HULT:
THE HILMA AF KLINT MUSEUM

Hilma af Klint (1862–1944) was a Swedish painter and a pioneer of abstract art. She made over 1200 paintings but stipulated in her will that her works were not to be shown until at least twenty years after her death. In her belief her contemporaries were not yet ready to understand her work. She imagined her central work – the series with 193 paintings named *Paintings for the Temple* – being shown in a spiral shaped building. The project offers a permanent exhibition space for Hilma af Klints work on Adelsö.

Studio 3, supervised by:
CARMEN IZQUIERDO

Contact details:
alva.hult@gmail.com



**LOUISE HUSMAN:
*A SUBSIDIARY BUILDING***

This is a thesis project with the initial intention to form a subsidiary to an existing building in Stockholm. It should be seen as an attempt to examine whether it is possible to complement a building of great architectural character without altering either its site nor its form. In the search for the traits of the concert hall in Stockholm by Ivar Tengbom, a complementing minor hall for music is proposed in the Bellevue park.

Studio 7, supervised by:
ELIZABETH HATZ
PETER LYNCH

Contact details:
louise.husman@gmail.com



JOHANNA JACOBSON:
SCHOOL BUILDING IN RIMBO – CHARACTERISTIC OBJECTIVITY

The program implies that there are meaningful things to find out about our realities in dialogue and discussion with others.

This search for a form for a school building is informed by a love for things inspired in part by the works of Pablo Neruda and Carl von Linné. Being interested in relations between ways of conceiving space and the shaping of building parts, I study existing buildings and try out structures by a country road and the edge of a forest on a site in the periphery of Rimbo.

Studio 3, supervised by:
JOHAN CELSING



**EIRA JACOBSSON:
DEMOKRATISKA RUM
– EN MÖTESPLATS I BREDÄNG**

The *common* has an important function in a democratic development of the city. The common as a link between the public and private. Interior common spaces are a lacking element in the city plan today, while the need is increasing with the ongoing densification.

With the concepts of flexibility and sustainability the project takes on an existing industrial building in the suburb Bredäng. With an interaction between program and spatial qualities, with dialogue and site analysis, a meeting platform is created.

Studio 3, supervised by:
CARMEN IZQUIERDO
ERIK STENBERG

Contact details:
jacobsson.eira@gmail.com



ARVID JANSSON:
GESTALT, EMPATHY, ORDER
– THE HUMAN MEASUREMENT IN THE TECTONIC

‘Let us yet again examine the pine. It *stands* there, in your perception, with its slender trunk, *lifts* its canopy, *reaches* with its branches, *grips* with its roots into the crevices of the rock. You perceive the pine as a gestalt, as a form, which expresses certain functions or motions of a being, a body. And such motions and functions are perceived through your own experiences of your own body, in your own sense, of your motions and functions.’

– Erik Lundberg, *Materia, Massa och Gestalt*

Studio 7, supervised by:
ELIZABETH HATZ
PETER LYNCH

Contact details:
arvid.jansson@bredband.net



**GABRIEL JOHANNESSON:
*THE KAYAK CLUB***

Stockholm offers unique possibilities with its 1122km of coastline through and around the city. One of those is the sport of kayaking with participants ranging from tourists to the dedicated practitioners. This project is a building that facilitates for both groups as well as curious passers by. The project is located on the western shore of Kungsholmen, just north of Tranebergsbron foot, where it aims to expose and further define a currently unarticulated space.

Studio 3, supervised by:
JOSEF EDER

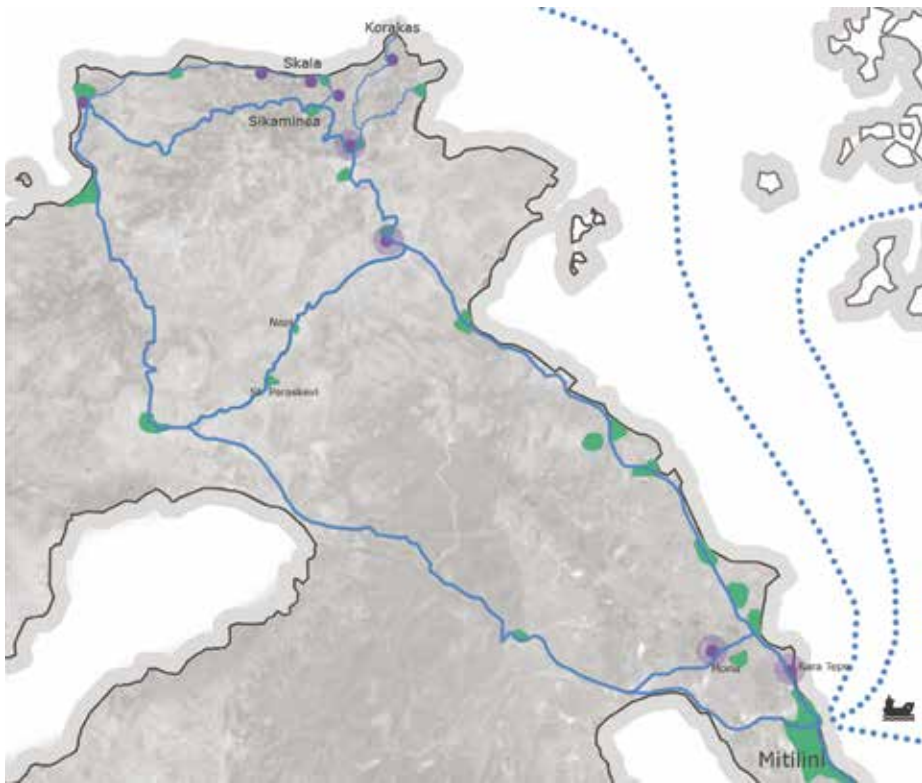

**MARIA KARAMANOU:
DEFENDING A FUTURE
– LOCAL SUSTAINABLE DEVELOPMENT ON THE ISLAND OF LESVOS**

The current issue of migration on the shores of the Greek islands is an ongoing humanitarian crisis with numerous repercussions. This project addresses the need for social interaction between the refugees of Lesbos and the local population. This new community requires restructuring and proper channels of communication. This work aims to create a meeting place for such a diverse public based on common ground and to bridge the existing gap by providing spaces of sharing and mutual exchange.

Studio 6, supervised by:
LEIF BRODERSEN
TERES SELBERG
CHRISTIN SVENSSON

Contact details:
ma.karamanou@gmail.com



**ANNA-MI KARLSUDD:
SPATIAL STORIES
– *STRANDGATAN 2-8***

Since 1954 a set of four meticulously drawn houses stands on Strandgatan, Borgholm. During 62 years the buildings have matured through use. The experiences of them as a home add a vital layer when understanding the building – yet the house is still represented as an object. The project studies the building as a result of being lived in. Through entangled stories and interrelated inquiries, the aim is to characterize the building as a whole and find other perspectives from which we may examine architecture.

Studio 8, supervised by:
SARA GRAHN
RUMI KUBOKAWA

Contact details:
annami.karlsudd@gmail.com



JAKUB KOLEC:
HOUSE K.

'I had to meet with someone very important, but wasn't stressed about that fact. I remember working on some industrial design. It felt a little bit like I am the creator, but at the same time, there's another entity that created my world and I. Just as if I am watching and being watched at the same time. Stuck in an infinite loop.'

Studio 4, supervised by:
CHARLIE GULLSTRÖM
ORI MEROM

Contact details:
cubature@gmail.com

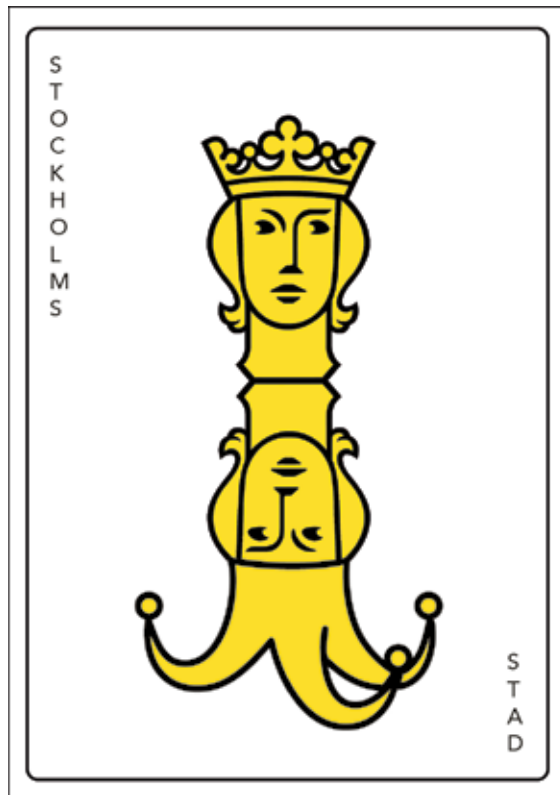

**MÅRTEN KYRKLUND:
GODKÄNT AV SKÖNHETSÅRÅDET**

Stockholms need for housing in the coming years is greater than when the Million Programme was at its peak. Is it a second Million Programme, with mass produced homes, that we need? According to the current architectural policy in Stockholm our common ideals speak a different language. We speak of a city with diverse architectural expressions and buildings adapted to local circumstances, non of which is met by mass production. What will happen to these city building ideals in times of need?

Studio 4, supervised by:
CHARLIE GULLSTRÖM
ORI MEROM

Contact details:
marten.kyrklund@gmail.com



**MADELENE LARSSON:
*ART GALLERY IN KATRINEHOLM***

The project aims to develop the central square *Stortorget* in Katrineholm and create a more lively city core. In 2014, the town planning office invited to a public architecture competition to design a residential building at this central site. Instead, this project proposes an art gallery for the public, to be a part of the square.

The purpose of the building is to create a natural interaction with the square and house cultural and social activities.

Studio 3, supervised by:
CARMEN IZQUIERDO

Contact details:
madelene-larsson@hotmail.com



LI BIAO:
DANCE CENTRE OF GOTHENBURG

My project is a new dance centre of Gothenburg. As a fast growing city, Gothenburg have lots of dancing company and groups, but the rooms for them are not enough. Even the biggest company have to survive under the umbrella of the Opera House. That's why I want to design a new culture building for them. My site is located on the new planning area which right opposite to the opera hall of Gothenburg. It will become a new centre of the city and a new skyline as well.

My project have 4 large rehearsal rooms with top view which can be divided into 8 smaller ones. It also contains a 400 seats performance room, several group rooms and rest rooms. The building can also be a new method to introducing dance. It's open, transparent and brightness, whether you are passing from street, overlooking from other side, sitting on the staircase or walking though the corridor, you can always see dancers training, feel it, enjoy it and then love in it.

Studio 3, supervised by:
JOSEF EDER

Contact details:
biaoli1990@gmail.com



TOBIAS LIDMAN & GUSTAV SVÄRDH WEIDEL:
TERRACED LIVING

Architecture is about prioritising. Space, money, place. They are all critical resources which are, in every project, finite.

This is especially true when it comes to housing. Adding a certain function often sacrifices another. If we are ready to accept that the current answers to how to prioritise space, functions and what can be shared is in need of a re-evaluation we open the door to new, or perhaps even old and underused spatial layouts of housing. What can we remove. To add. To improve?

Studio 6, supervised by:
LEIF BRODERSEN
TERES SELBERG
CHRISTIN SVENSSON

Contact details:
tobias.lidman@gmail.com
gustav.sw@gmail.com

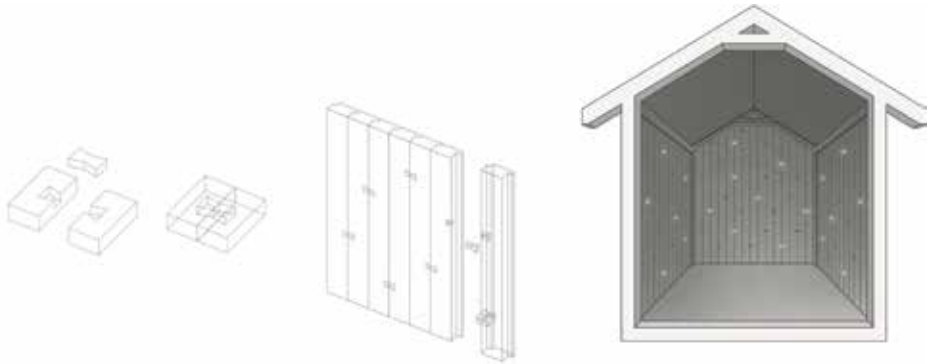

**ISABELLE LINDBLAD:
*WOOD + WOOD***

In a country covered with forests, why not put wood to maximum use? If wood joints are just as good without glue or metal, do we really need to use these non-renewable materials? By designing an all-wood playhouse, I wanted to look into how wood joinery can be used in buildings. What its limits are, and what contemporary potential it might have - environmentally, structurally, economically, and aesthetically.

Studio 1, supervised by:
EBBA HALLIN
JOHAN PAJU

Contact details:
isabelle.lindblad@gmail.com



**VALTER LINDGREN:
*AN ARCHITECTURE OF BRICOLAGE***

Society is driving itself to its own destruction. How can architecture pull the culture towards a stable course? Bricolage – a construction made of whatever materials are at hand – became the main theme of my investigation, and what was given for free on *blocket.se* became the construction material I allowed myself to use. An array of basic architectural problems were answered in a hands-on manner, sometimes in a more inventive spirit and sometimes while glancing at older, easier methods.

Studio 7, supervised by:
ELIZABETH HATZ
PETER LYNCH

Contact details:
valterlindgren@gmail.com



**JOHAN LINGMARK:
SAVING THE IDEA OF DHARAVI**

Dharavi, Asia's largest slum and industrial zone, is facing significant turmoil. The whole area will undergo a redevelopment phase spanning the next seven years. My thesis project aims to maintain the craftsmanship and valuable knowledge into the new area. My vision revolves around a sustainable craftsmanship center, which will attract jobs, recycle garbage, inspire visitors and enhance knowledge.

Studio 3, supervised by:
JOHAN CELSING
JOSEF EDER
CARMEN IZQUIERDO

Contact details:
j.lingmark@gmail.com

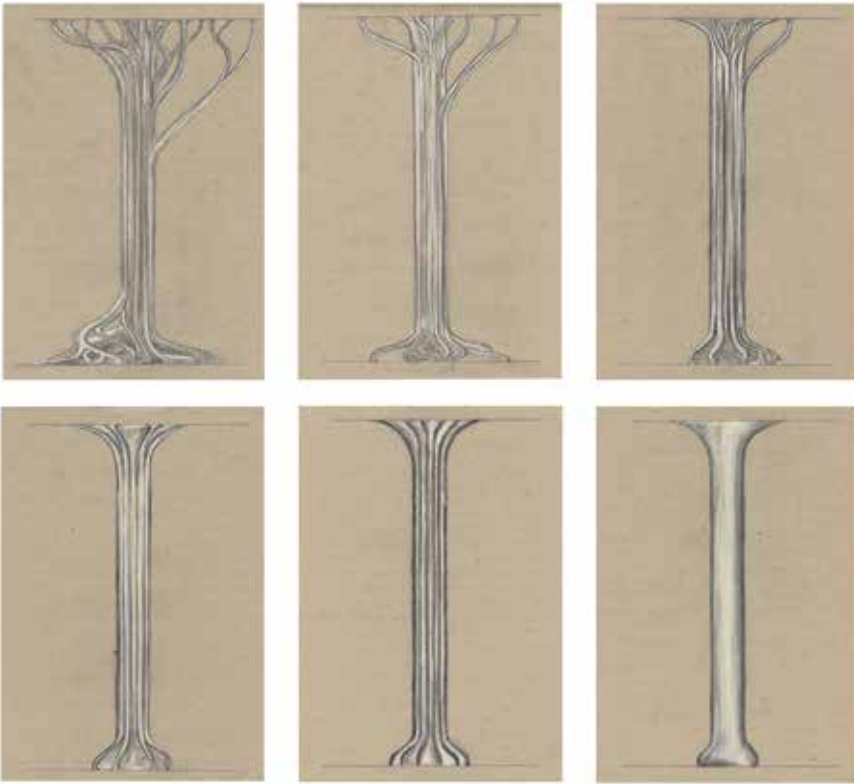

FELIX LOTZ:
A CONVERSATION BETWEEN ART NOUVEAU AND DIGITAL DESIGN

What are the similarities and differences of Art Nouveau architecture and the curvilinear designs of today?

This thesis explores design methodology, theory and form, and the process of abstraction in the Art Nouveau period 1880-1915 and contrasts it with curvilinear computer aided design discourse and buildings between 1980-2015. This will be presented through explorative drawings, literature studies and design drafts as conversational alternative proposals to built structures.

Studio 9, supervised by:
ANDERS BERGSTRÖM
JONAS RUNBERGER
ELSA WIFSTRAND

Contact details:
felixlotz@septago.com



EMILIA LYONS:
CAPTURING MOMENTS

This project explores the moments in architecture that leaves you either wanting to linger in a place or longing to explore more beyond what you can see. Inspired by fragmented moments in the town of Lund, the ambition was to use the essence I found in them, and unite them into one coherent whole.

Studio 7, supervised by:
ELIZABETH HATZ
PETER LYNCH

Contact details:
emilia.lyons@hotmail.com



LISA MELIN MAHFOUZ:
ENLIGHTENING LEARNING
– A SCHOOL CRAFTED BY LIGHT RATHER THAN TIME

The Swedish school system has been criticised in recent years. One reason is that contemporary school architecture is becoming increasingly uninspiring to its users, thus creating a significant distance to what school really should be about – the joy of learning. I have chosen to address this issue through an in depth study of light and its possible impacts on spaces for learning. The aim of my project has been to give a conceptual answer to how this architecture for learning might look like.

Studio 4, supervised by:
CHARLIE GULLSTRÖM
ORI MEROM



JESPER MELLGREN:
KTH CHAPEL
– A PLACE FOR QUIET REFLECTION ON CAMPUS

The Swedish University Chaplaincy operates on all major campuses in Sweden offering confidential counseling with representatives of different religions. Currently their physical presence on different campuses are often hidden or inaccessible and they wish to more clearly manifest their existence in the university environment. Based on their current practice, a non-denominational chapel complex is proposed in the very heart of the KTH campus. A place for contemplation in a stress-free environment

Studio 3, supervised by:
JOHAN CELSING

Contact details:
www.jespermellgren.com
jm@jespermellgren.com

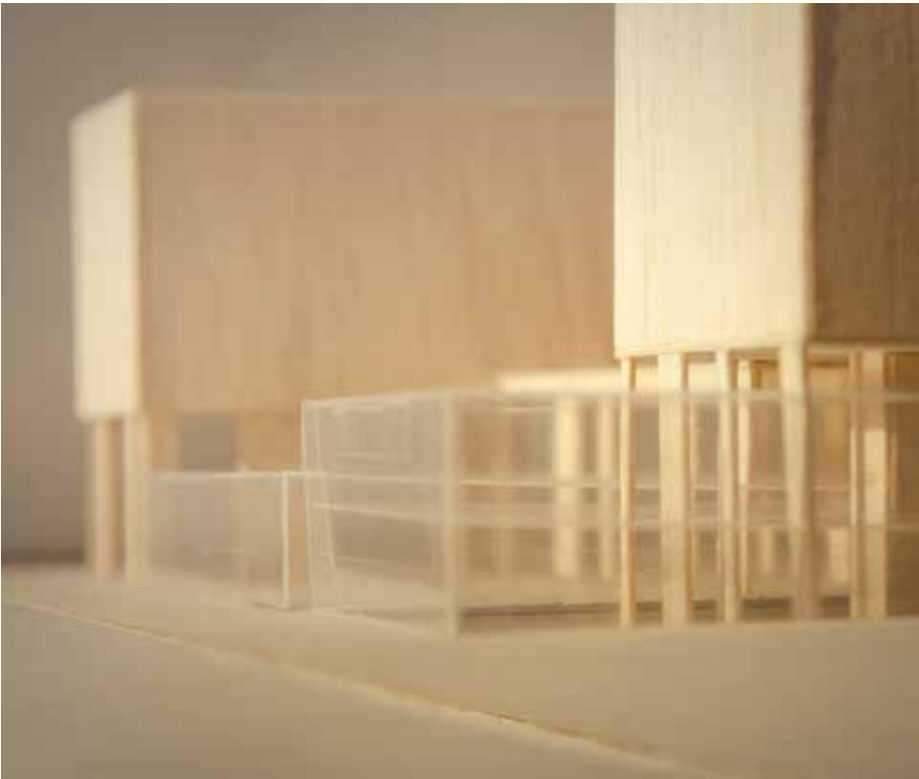

PAVEL MUSAMBA:
MASS TIMBER INFILTRATION.

Mass timber construction – the new hype in architecture, and conversion – the evident necessity in a rapid growing city. The two concepts are merged to re-purpose and expand on a 5 decade old industrial building.

The mass timber structure infiltrates through the old building from above transforming its interior spaces for new function while supporting the new housing above.

Studio 9, supervised by:
KAYROKH MOATTAR
JONAS RUNBERGER
JULIEN DE SMEDT
ELSA WIFSTRAND

Contact details:
pavel-101@hotmail.com



EMILIE NÄSLUND:
FLUCTUATION THROUGH STATES

By the end of this century the Arctic Ocean could be completely ice free during late summer. Greenland still has a majority of settlements relying on hunting, and the use of their environmental assets makes it one of the most affected areas. Relocation to bigger cities soon seems to be the only choice to make a living even though a lack of education makes it problematic. The aim of this project is to find an alternative way of life that still sympathises with their cultural identity.

Studio 4, supervised by:
CHARLIE GULLSTRÖM
ORI MEROM

Contact details:
emilienaslund@hotmail.com



JOHAN NILSSON:
DWELLINGS IN BAGARMOSEN

Housing of today is to a great extent informed by practical and utilitarian aspects, these aspects are not in themselves negative but something more is needed to create meaningful spaces to dwell.

The intent of the project has been to design dwellings that in addition to the practical aspects deals with atmospheres and with affordable means aims to create spaces that evoke feelings such as curiosity, wonder and serenity.

Studio 3, supervised by:
JOHAN CELSING

Contact details:
johannilsson3000@gmail.com

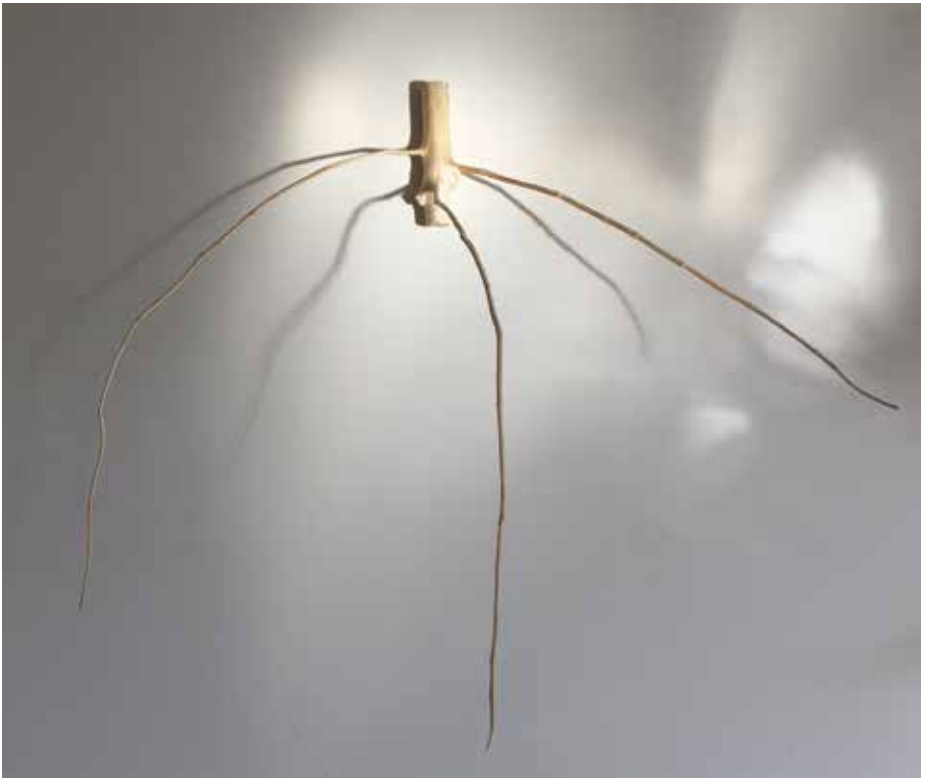

EVA NYBERG:
ELEMENTAL

Architecture is often towering and seemingly in control; Mans victory over Nature. But everything moves and we are not always in control. Temperature, humidity and light are some of the factors that can transform the colour, size or state of a material. This is a fascinating synergy. Elemental is a study of shapeshifting materials that reversibly transform solely due to the surrounding elements. Can the natural processes be modified and enhanced, and can the shapeshifting be used in architecture?

Studio 1, supervised by:
EBBA HALLIN
JOHAN PAJU

Contact details:
eva.k.nyberg@gmail.com

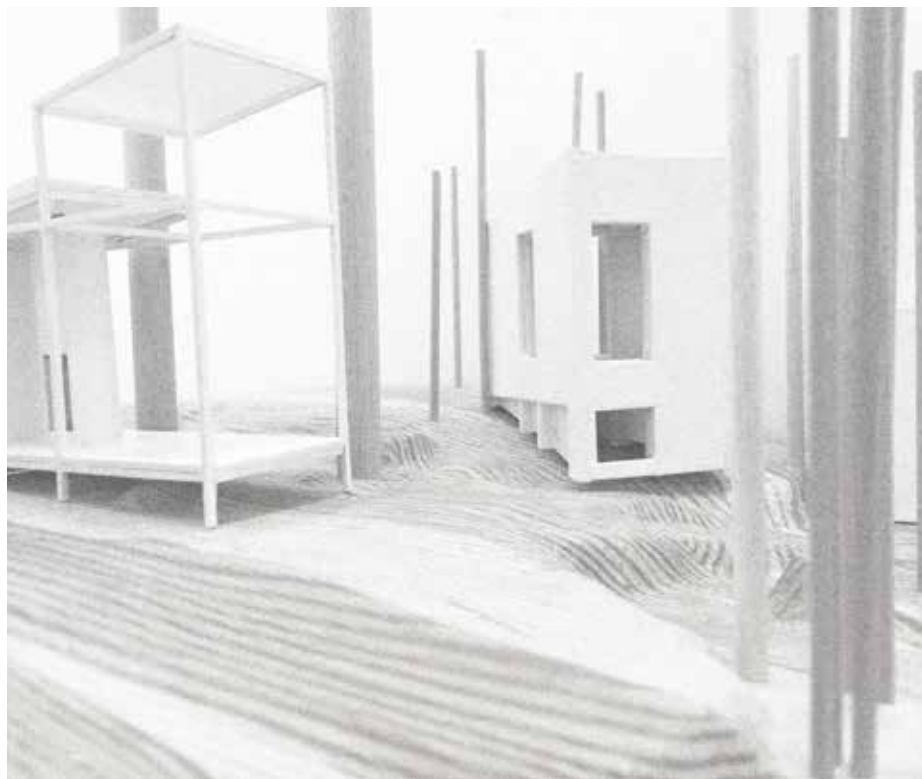

BENJAMIN ONOSZKO
BOSTAD
– *ARKITEKTUR/NATUR*

A new analysis and design method where a house for one person slowly develops in a specific place. The project is in the border of architecture and nature.

Studio 6, supervised by:
LEIF BRODERSEN
TERES SELBERG
CHRISTIN SVENSSON

Contact details:
benjamin.onoszko@gmail.com

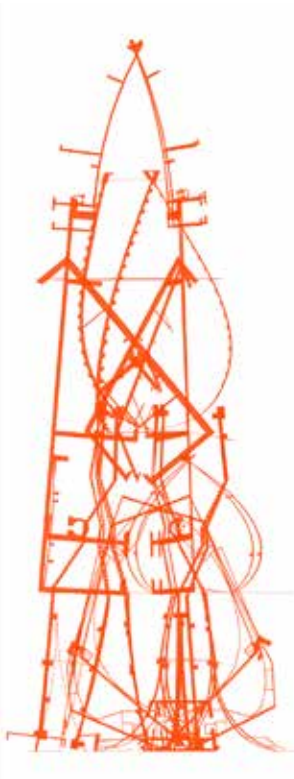

**LISA PALM:
THE TOWERS OF TIME
– ON THE THRESHOLD BETWEEN OBJECT AND REPRESENTATION**

‘Architects do not make buildings, they make drawings for buildings.’

– Robin Evans

The three towers stand by the water, projecting reflections in the waves. Permanently temporary, forever in a state of *always* and *never*. Drawings from the previous buildings on the site are used as building material, the moments of history are carelessly deconstructed and carefully reconstructed. How can the architectural object and its representation interlace?

Studio 5, supervised by:
ULRIKA KARLSSON
EINAR RODHE

Contact details:
palm.lisa@gmail.com



JACK PHIPPS:
CRYSTAL ARCHIVE
– A VIRTUAL BANK FOR LONDON

In a world that is perpetually evolving with new technology, the digital realm is becoming more intertwined with contemporary society offering new innovations for design in 4 dimensions of space. The ruins of Crystal Palace offer a stage to catalyse the conversation between the analogue and the digital by resurrecting the zeitgeist of the past into a new being. Digital information collated is projected back locally into a physical entity, yet also allowing for access to the global community.

Studio 4, supervised by:
CHARLIE GULLSTRÖM
ORI MEROM

Contact details:
jackphipps88@msn.com



**HILLEVI ROBERTSSON QUINN:
ÖREBRO MARKET HALL
– A SECOND CHANCE AT A NEW LIFE**

How does one restore the original life and program to a building that has been repurposed several times over the preceding decades? In the 1950s, Örebro had a fine market hall with great light and spaces. In the 1970s a supermarket took over the space, and the old roof with its skylights was demolished, but the original construction remains today. Reusing the old structure while adding new elements, I am giving new life to the old market hall and bringing back open spaces and natural light.

Studio 3, supervised by:
JOHAN CELSING
CARMEN IZQUIERDO
JOSEF EDER

Contact details:
hillevi.robertsson@gmail.com



ANNA RODIN:
A FILM MUSEUM
– FRIHAMNEN, STOCKHOLM

The projected image creates an immaterial space that stands in contrast to the physicality of architecture. Based on these two aspects – the visual/atmospheric and the tactile/haptic - the project explores the potential of film projection and its perception in the exhibition space.

The program aims to create a platform for curatorial work with film, to deepen its relevance and contextualize history. My work with the building design reflects on three film concepts: long take/montage/mise-en-scène.

Studio 8, supervised by:
SARA GRAHN

Contact details:
anna.rodin@yahoo.com



ANDERS STENHOLM:
THE HOME AND THE ATMOSPHERE

The perception of spatiality is the result of several components and factors. Spatiality affects humans and is interpreted in the same moment that the eye meets the room, with all the factors joined in a context; the room's atmosphere. In my thesis, I have worked with housing in Solna Kyrkby and the driving force has been the atmosphere of the home.

Studio 3, supervised by:
JOSEF EDER

Contact details:
andersstenholm@hotmail.com

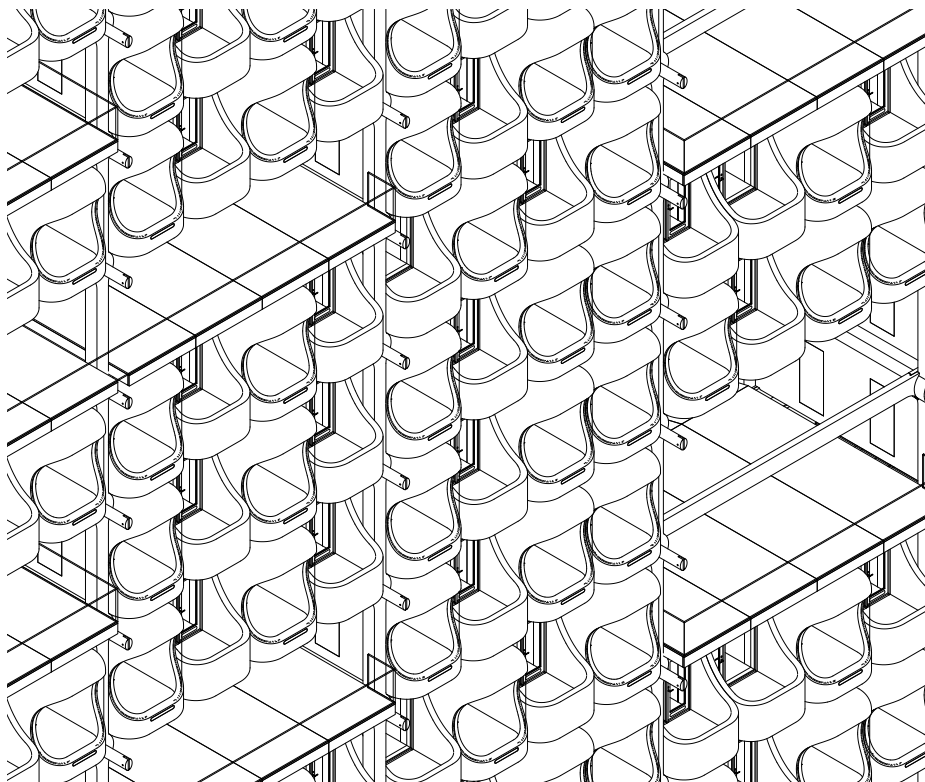

HJALMAR STENLUND: *RETHINKING LIVING*

Rethinking Living is about how our lives changes during one's lifetime but the architecture that we live in has always been lacking the ability to do so. By creating a new system for living this could however change. Today we move from country to country, from city to city and from apartment to apartment. Some people tear out the old to make space for something new while others replace the new with something looking old. It is a both money and energy consuming way of living, a living worth rethinking.

Studio 4, supervised by:
CHARLIE GULLSTRÖM
ORI MEROM

Contact details:
hjalmarstenlund@gmail.com

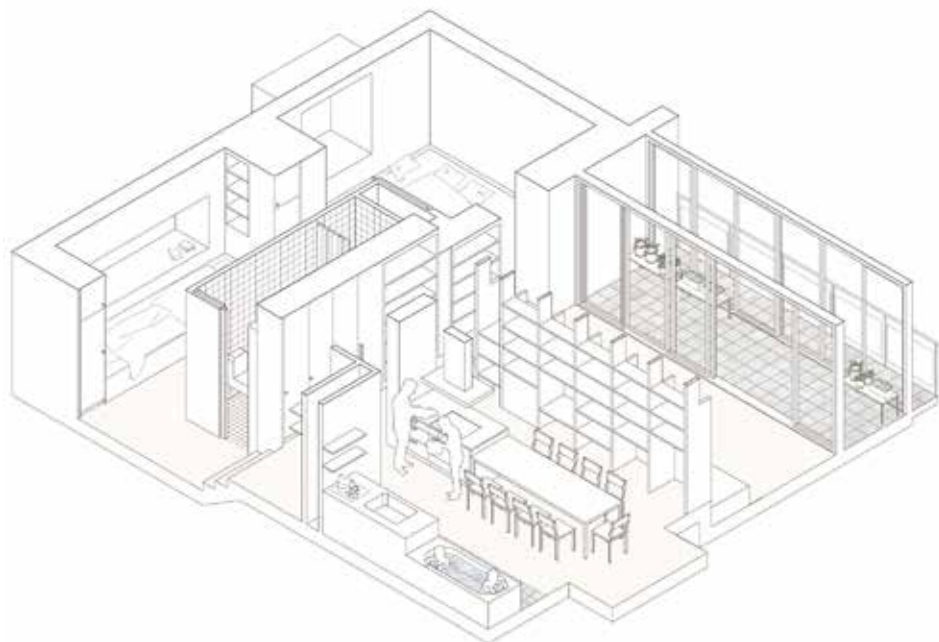

**FRIDA STJERNQVIST:
SAMTIDA BOENDE**

Looking at plan drawings of housing from a certain time, gives you an idea of what political visions and what ideals there were in society at the time they were designed. It is easy to start imagining what kinds of lives were lived there. In my project, I investigate what an apartment could be today. I introduce new ways of organising an apartment and by that, possibly new ways of organising life.

Studio 2, supervised by:
TOR LINDSTRAND
ANDERS WILHELMSON

Contact details:
frida.stjernqvist@gmail.com



**KAMELIYA STOYANOVA:
*ON THE EDGE***

On the west coast of the Black Sea, lies a city along the water's edge. At the meeting point of city and sea is an expansive garden that houses the cultural, recreational and entertainment life of the city. Here, visitors experience a rare joy, a marine atmosphere amongst forested slopes. But as the city sprawls, the garden shrinks and the connection between city and sea has been lost. This project aims to reweave and unite the urban fabric, prompting the next chapter in the gardens story.

Studio 10, supervised by:
ALEXIS PONTVIK
INGRID SVENKVIST

Contact details:
kamistoyanova@gmail.com

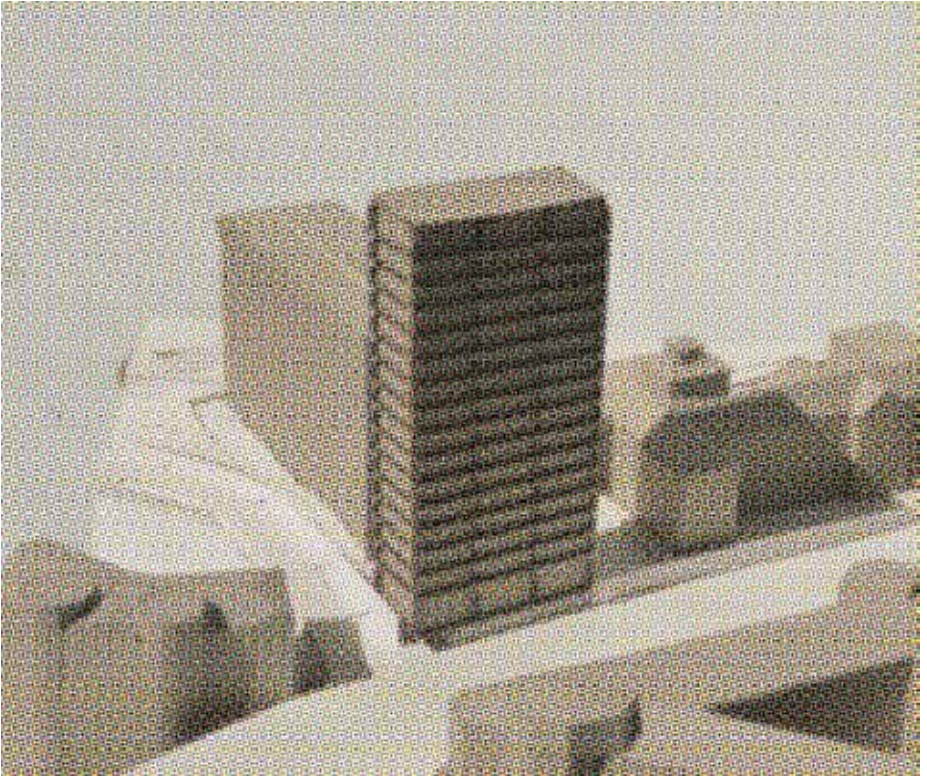

**LOVA STRINDBERG:
*SABBATSBERG 18***

At the foot of the bridge of Barnshusbron in the citycenter of Stockholm, an apartment building rises above its neighbors, presenting an elevated view of the city and participating in its urbanity.

Each floor contains three apartments. The living spaces are similar in size and proportion, and are organized around a core of fixed functions. They are designed with three keywords in mind: enclosure, axiality and circulation.

Studio 3, supervised by:
JOSEF EDER

Contact details:
lovastrindberg@gmail.com



**JOHANNES SVERLANDER:
THE KING, THE ARCHITECT & ALTERNATIVE REALITIES
– “ONCE UPON A TIME THERE WAS A THEATRE...”**

How can history be used when designing a theatre in the park of Haga?

Just like a theatre play, history is balancing between reality and fiction. This work uses architectural history in a playful way to create a theatre in the royal park of Haga just outside of Stockholm. King Gustav III (1746–1792), also known as The Theatre King, appointed Jean Louis Desprez (1743–1804) head architect for his grand plans in Haga. Some were realized, while others remained fantasies.

In my work I use (and abuse) drawings of Desprez to explore how ideas of the past can be used to compose a theatre of today.

Studio 5, supervised by:
ULRIKA KARLSSON
EINAR RODHE

Contact details:
johannes.sverlander@hotmail.com

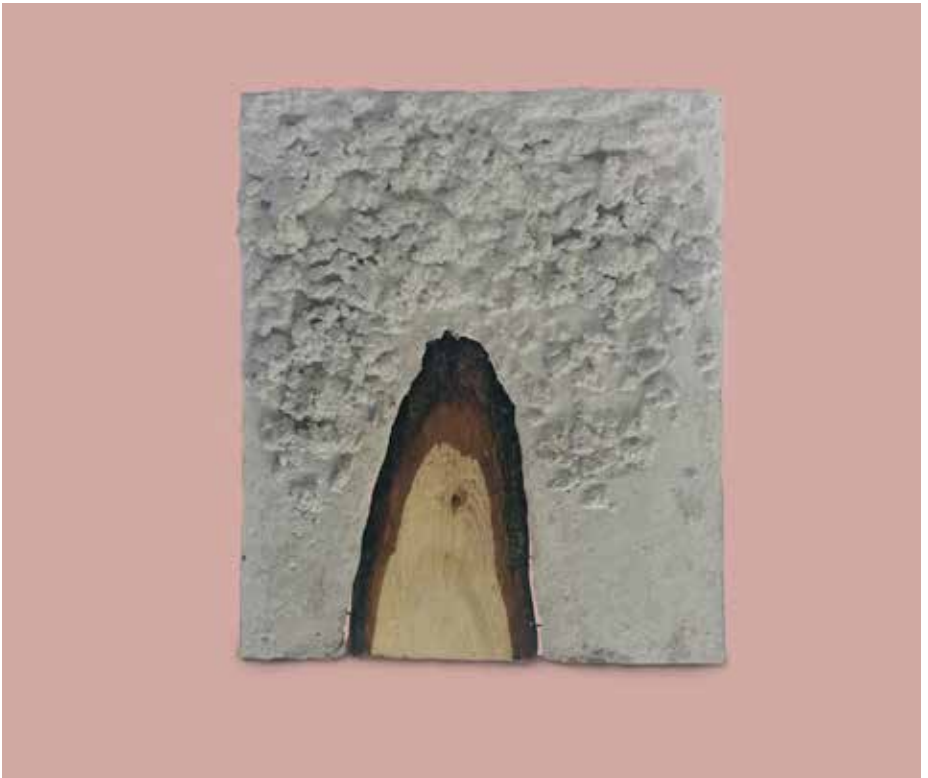

**JAKOB VALENTIN:
*URBAN DISCONNECTION***

In architecture, wood and concrete are often implemented as two separated materials with little interaction. This project explores the possibilities of merging these materials in unconventional ways. How can wood and concrete interlace in a stage where they normally don't? How does this effect the design? Just like us, they connect and disconnect. The research is applied on a building for ceremonial events, also serving as a recovery space from the hectic every day life – an urban disconnection.

Studio 5, supervised by:
ULRIKA KARLSSON
EINAR RODHE

Contact details:
jakobvalentin@hotmail.com



JOAKIM WADENHOLT:
THE VERTICAL VILLAGE OF SAU MAU

For centuries, urban villages with informal architecture and individual freedom have formed East Asia. Since the second part of the 20th century, these urban villages are rapidly disappearing to make way for massive concrete towers with repetitive housing units. This project speculates on a possible alternative to these concrete towers. By reintroducing the village in a vertical approach and with a vertical attitude, the idea is to bring back the qualities of the village to East Asia.

Studio 4, supervised by:
CHARLIE GULLSTRÖM
ORI MEROM

Contact details:
joawad@kth.se

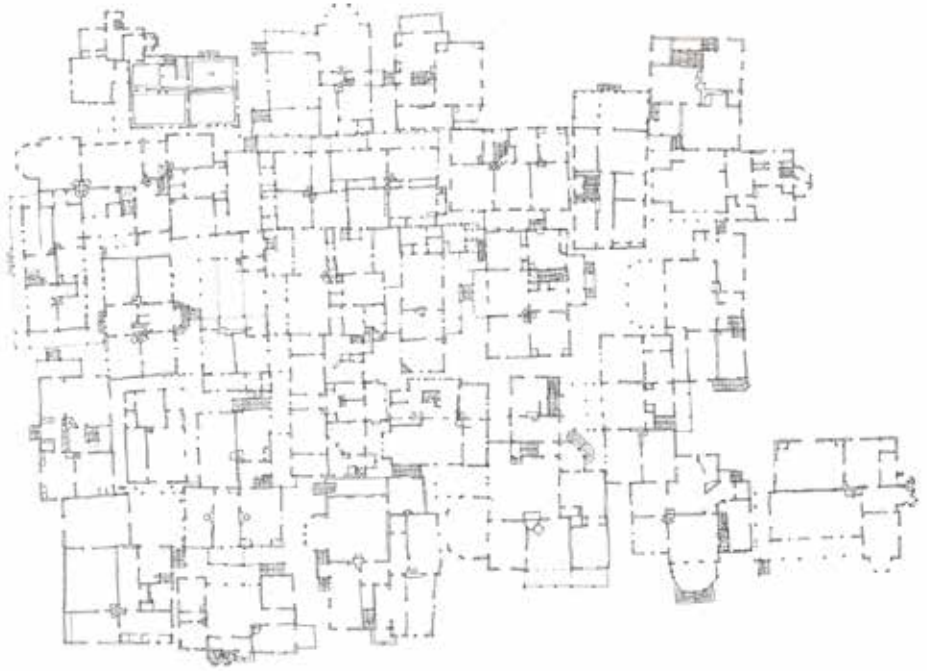

GUSTAV WALLERIUS: *ROOMS OF RINDÖ*

This project started with an observation of spatial similarities amongst early summer villas. The villas observed were made for a specific period of time. Since then, many summer houses have been constructed, but the possibility for year-round living in the region has not grown accordingly.

The project drawn is permanent housing for the elderly – a specific demographic chosen to make us consider a place where one spends more time than in an average house.

Studio 3, supervised by:
JOHAN CELSING
JOSEF EDER
CARMEN IZQUIERDO

Contact details:
gustav.wallerius@gmail.com



**LOVISA WALLGREN:
THE GALLERY OF SCULPTURES
– A MUSICAL COMPOSITION OF SPATIAL SEQUENCES**

A reflection on the perception of spatial sequences, how they work and how they are composed. The musical terms Staccato, Legato and Crescendo are used to depict different kinds of sequences. The reflections on sequences are used in composing the Gallery of Sculptures, situated in a northern slope next to the Mosebacke terrace overlooking the inlet to the heart of Stockholm.

Studio 7, supervised by:
ELIZABETH HATZ
PETER LYNCH

Contact details:
lovisa.wallgren@gmail.com



**ANNA WEGLIN ELENIUS:
TEXTILE TRANSLATIONS OF THE ORDINARY**

The ordinary room is shivering. Solid fragments spread out along floor, walls and ceiling. They struggle to maintain order but time and again they are interrupted in the middle of a sentence.

Through a full scale installation, this project explores translations of ordinary architectural elements by imitating and distorting them. Textiles pleat, wrinkle, swell and unfold along the rigid. The installation deals with unexpected material behavior, ordinariness and legibility. What happens to the ordinary room?

Studio 5, supervised by:
ULRIKA KARLSSON
EINAR RODHE

Contact details:
weglenius@yahoo.se

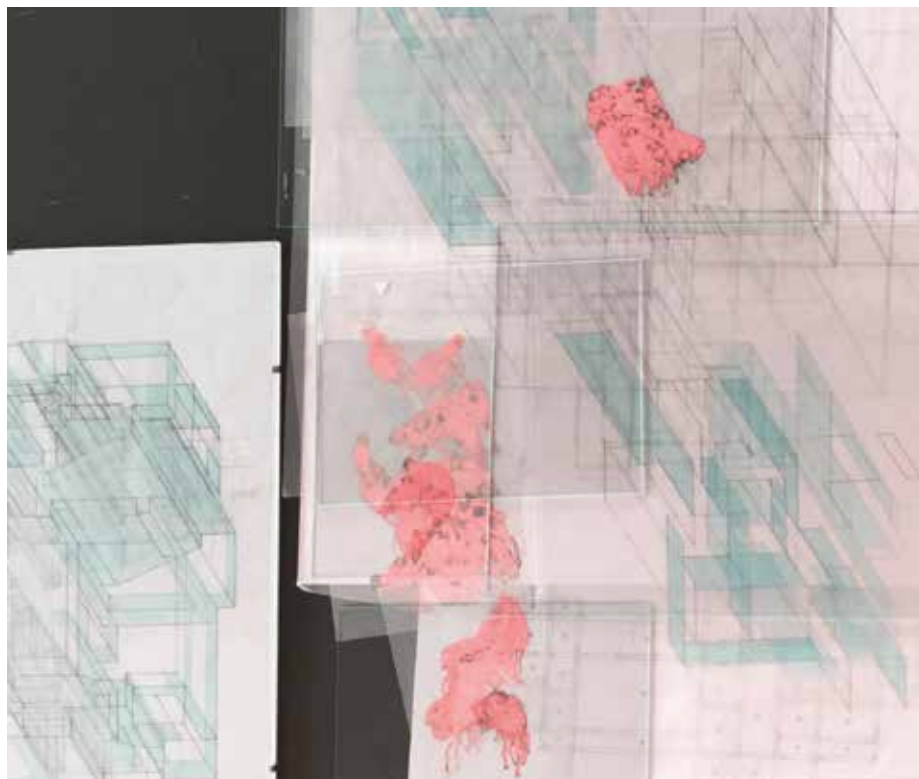

RASMUS WESTMAN:
THE PIG
– DEFINING AN ARCHITECTURAL IDEOLOGY

A process of developing an architecture layer by layer. Each drawing generated on top of the previous; each one becoming a frame in a time-lapse.

Like the plates of Eadweard Muybridge each still is not just a two-dimensional projection of, for instance, a pig, but one in a series of images revealing the movements of this pig – of a real, more complex existence.

Looking at this process of drawing, what can we read from it? If these drawings are only *stills* of a trotting pig, what is the *real* pig?

Studio 2, supervised by:
TOR LINDSTRAND
ANDERS WILHELMSON

Contact details:
rasmuswestman@gmail.com

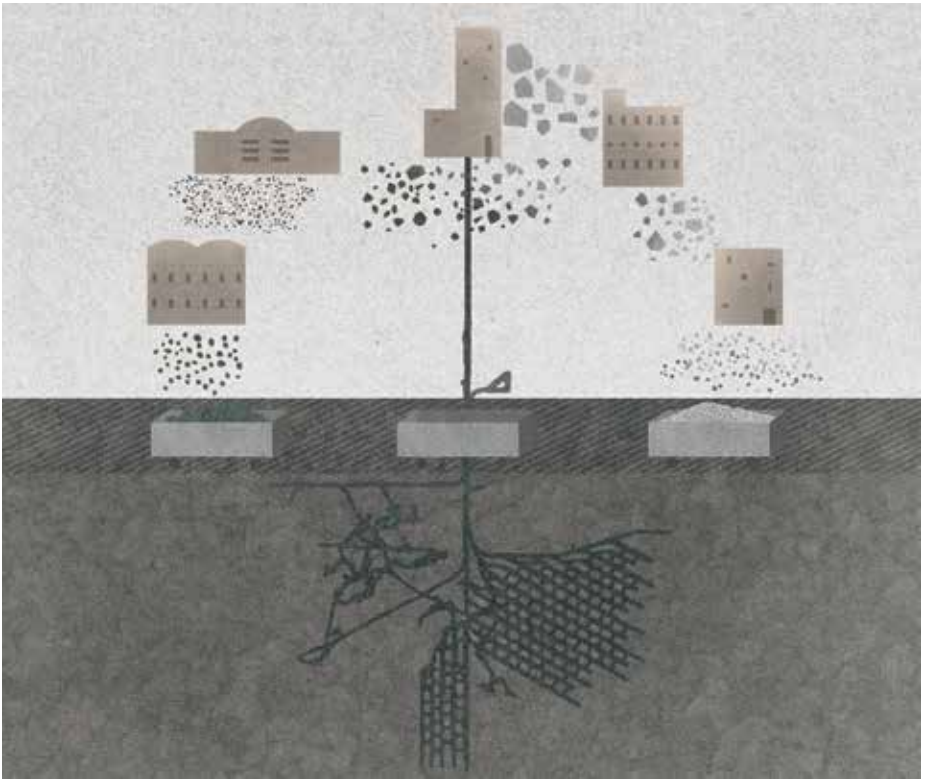

**FANNY WETTERROT:
SIX HUNDRED FEET UNDER
– CEMETERY IN A BERGSLAGEN MINE**

This project explores how an existing monumental structure, formerly used for production, can change program and inform the architectural approach, in both movement and materiality.

For centuries this site was used for ore mining, but 40 years ago the ore ran out and the grounds were abandoned.

In this proposal the mine and the buildings left behind have been turned into a funeral site, to refill the holes in the ground.

By reversing the movement of the ore through the site, the body finds its way back into the soil.

Studio 5, supervised by:
ULRIKA KARLSSON
EINAR RODHE

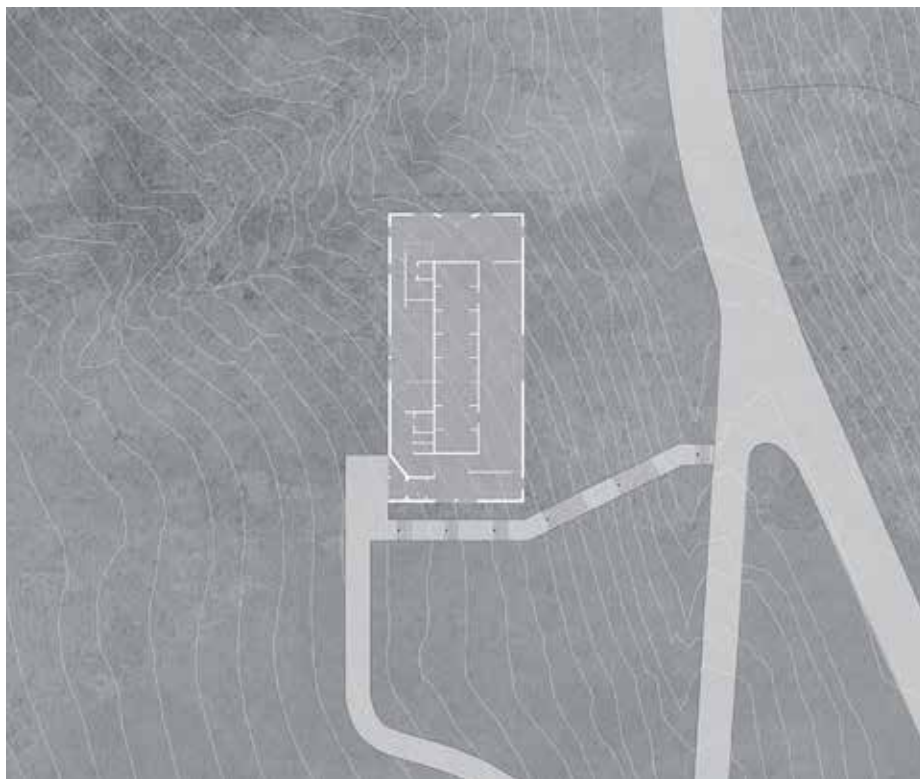

JOEL YNGVESSON:
EX SITU – CROP DIVERSITY ON DISPLAY

Svalbard is the unlikely home to the largest collection of seeds in the world. The seed vault is a telling image of the islands future, once a coal mining society, now targeting science and tourism as economic growth factors.

How can the importance of the vault and its contents be mediated in a tangible and atmospheric way? Striving to be in dialogue with regional architecture of the past, this project proposes a building communicating the importance of seed diversity and the Svalbard Seed Vault.

Studio 3, supervised by:
JOHAN CELSING

Contact details:
joelyngvesson@gmail.com



TIANLE YU:
STAIR AS IMAGE

As we know, image is a very efficient medium for recording and transmitting information. Nowadays, the production of image and accessibility to image has become much easier than any time among history. We are surrounded by images all the time.

My thesis project is about reconsidering how architecture is connected to other form of art and culture, discussing possibility of taking image as reference in process of architectural design.

Studio 7, supervised by:
ELIZABETH HATZ
PETER LYNCH

Contact details:
tianle.yu.chn@gmail.com

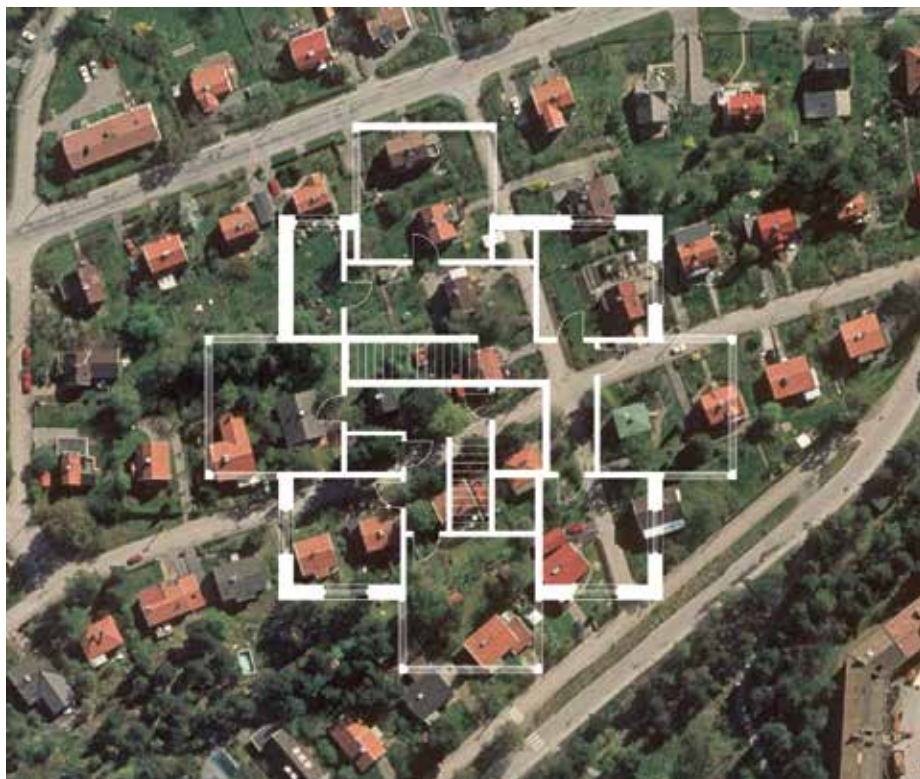

DANIEL ZETTERBERG:
SHIFTING SCALE – THE URBAN VILLA

Within the context of a suburban single family housing neighbourhood in southern Stockholm, this project proposes a border typology, somewhere between an urban building and the villa. It explores the possibilities of densification and the overlapping of different sides of everyday life.

Studio 7, supervised by:
ELIZABETH HATZ
PETER LYNCH

Contact details:
d.p.zetterberg@gmail.com



OSKAR ÅSTRÖM:
MUSEUM OF DARKNESS

In our building culture of today a lot of care is typically spent on the performance of light, but darkness itself is seldom consciously included in the architectural design. It is an often overlooked element of architecture that deserves a closer study, as its absence leads to an impoverishment of the architectural experience. This study aims to explore how darkness and shadows can be created and manipulated, and to find ways to work with that within a building dedicated to the experience of the lack of light.

Studio 5, supervised by:
ULRIKA KARLSSON
EINAR RODHE

Contact details:
oskaraastroem@gmail.com

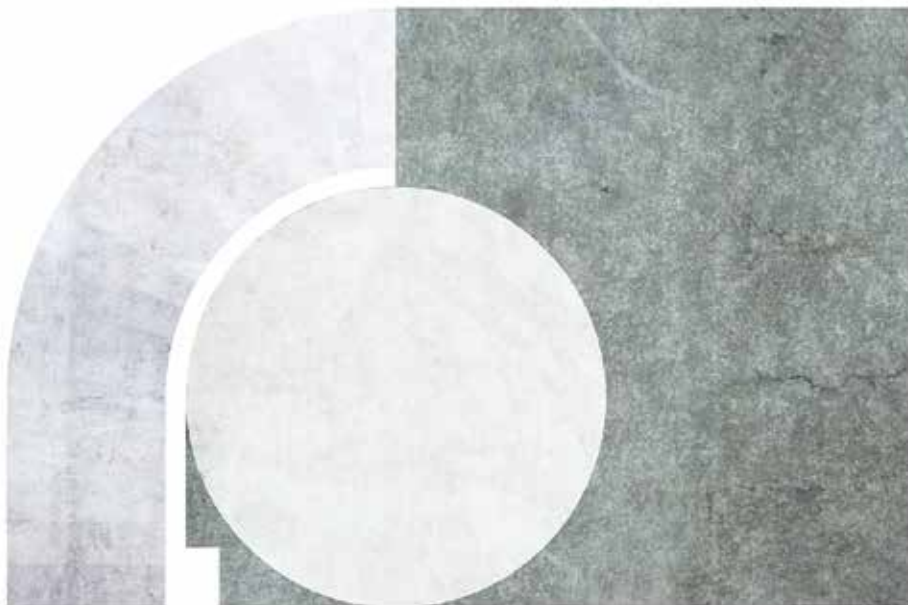

RAKEL ÖSTLUND:
CONSTRUCTING AN ARCHIVE

The aim of my thesis project is to construct an architecture institution where the architecture archive has been the driving force; both in terms of the program as well as informing my method.

My project investigates how the conception of Swedish architecture history can be interpreted and transformed into fragments. These have dictated the design in order to link the archive to the archive building. As a result of my method of assembling fragments, the archive becomes an archive over itself.

Studio 7, supervised by:
ELIZABETH HATZ
PETER LYNCH

Contact details:
rakelostlund@hotmail.com

**SUSTAINABLE URBAN PLANNING & DESIGN DEGREE PROJECTS:
PRESENTED ON MAY 30-31**

SUPD Degree projects by:

HANNA BECIROVIC
ERIKA FAGERBERG
& MARINA ZIANKOULI
EIRINI FARANTATOU
LAURA GIOANETTI
ALBIN GRIND
& AXEL LINDQVIST
STEFANIA KAPSAKSKI
& MARIA-ANTONIA STAMOULI
OKSANA KOLBOVSKAJA
KONSTANTINA KONSTANTINO
YANG LUO
SARA MALM
BRYANS MUKASA
DENNIS SÖDERHOLM

SUPD Jury:

SHIRA JACOBS
LAURA NOVO DE AZEVEDO
JAN SCHOTT
ANIA ZDUNEK

www.fruangencentrum.se



www.kistagalleria.se



www.jakobsbergscentrum.se



www.liljeholmsforget.se



www.hogdalencentrum.se



www.stenungsforget.se



www.tumbacentrum.se



www.akersbergacentrum.se



www.columbus.fi



50+

THE SPREAD OF THE HOMOGENEOUS

HANNA BECIROVIC: COUNTERBALANCING GENTRIFICATION

New districts are emerging in Stockholm that are built for a wealthier class. This brings many societal changes and divisions. The renewal of Fruängen might follow this current pattern with commercial activities as the main focus. Can a planner influence the shape of gentrification? A disconnection has appeared in Fruängen between communities. My reaction to this has been to work with the term counterbalance – to counter the privatization that is taking over by fronting the public.

Studio SUPD, supervised by:
THÉRÈSE KRISTIANSSON
MARIA ÄRLEMO

Contact details:
hannabec@kth.se



ERIKA FAGERBERG & MARINA ZIAKOULI
RINKEBY – EXPLORING FEMINIST DESIGN TOOLS

Although to the general public gender inequality is not considered a problem today, the design of many public spaces still overlook the female perspective. Located in Rinkeby, this project explores ways to redefine the relationship of women and space through urban design. The effort was put on understanding the variety of female voices in Rinkeby, and starting a discussion about the tools we, as planners and architects, have at our disposal when we aim to create a more feminist urban experience.

Studio SUPD, supervised by:
DANIEL KOCH
THÉRÈSE KRISTIANSSON
MARIA ÄRLEMO

Contact details:
erika.fagerberg@gmail.com
marinaziakouli@gmail.com

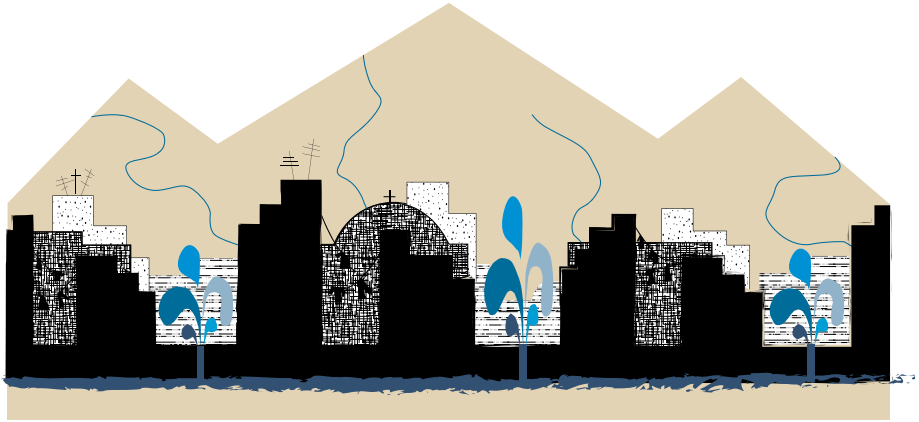

EIRINI FARANTATOU:
FLOODING THE CITY
– *CREATING DYNAMIC SPACES FOR WATER*

Focusing in inland floods and in areas of spatial injustice (ecologically and socially deprived) this thesis opts for climate change mitigation and adaptation through an alternative for flood resistance. Floodplains are treated as an asset revealing the dynamic role of landscape and public space into generating engagement, strengthening communities and raising awareness.

Studio SUPD, supervised by:
MARIA GREGORIO
PATRICK VERHOEVEN

Contact details:
e.farantatou@gmail.com



LAURA GIOANETTI:
PERIPHERIES: NOT PROBLEMS BUT ASSETS

Peripheries, as a result of a common negative perspective, are often seen as problematic areas for which ‘amelioration’ is possible just by their demolition.

The project, taking the case of Begato (Genoa, Italy), shows instead possibilities for intervention by interpreting peripheries not as problems but as assets. Making the most of the potentials, it is then proposed the activation of the existing spaces and social capital through the design of a community gardening network.

Studio SUPD, supervised by:
ÅSA DROUGGE
GÖRAN LINDBERG

Contact details:
laura.gioanetti@gmail.com

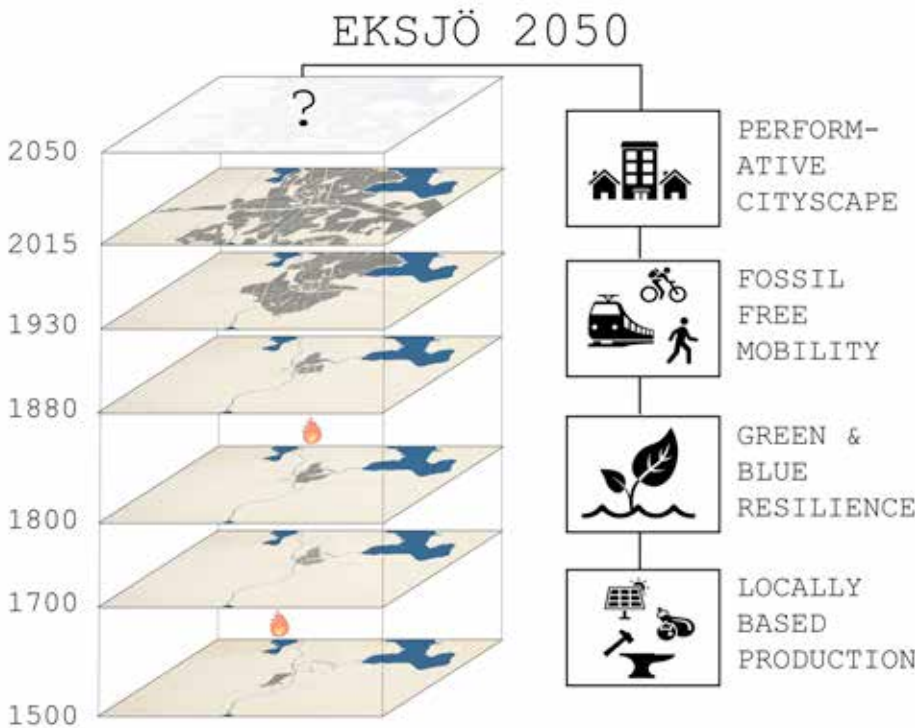

**ALBIN GRIND & AXEL LINDQVIST:
EKSJÖ 2050
– TOWARDS LOCAL SUSTAINABILITY**

We are facing an era of crises; peak-oil, peak-food, peak water – peak everything! Our unsustainable lifestyles depletes the Earth’s natural resources and destroys the planet. In the post peak future we must plan for self-sufficient societies that use local renewable resources in an efficient way.

The project will present a comprehensive plan for the small Swedish town Eksjö, as well as a development proposal for *The New Wooden Town* – Eksjö’s new sustainable neighborhood.

Studio SUPD, supervised by:
MARIA GREGORIO
PATRICK VERHOEVEN

Contact details:
axel.lindqvist@hotmail.com
albin.grind@hotmail.se



**STEFANIA KAPSAKSKI & MARIA-ANTONIA STAMOULI:
*FILLING IN THE GAP – REDEFINING THE PLACE OF ABANDONMENT
IN THE CITY OF ATHENS***

Today there are more than 1,200 abandoned buildings in Athens while there are more than 10,000 homeless people experiencing the crisis. Our basic proposal is the reuse of the buildings to provide homeless people with the means to satisfy their needs, supported from urban farming and public spaces. The case study is a complex of three abandoned buildings within a park. Following this example our final vision is the implementation of this model and its typologies in multiple neighborhoods of Athens.

Studio SUPD, supervised by:
THÉRÈSE KRISTIANSSON
MARIA ÄRLEMO

Contact details:
mstamoligo@gmail.com
stef_kaps@hotmail.com

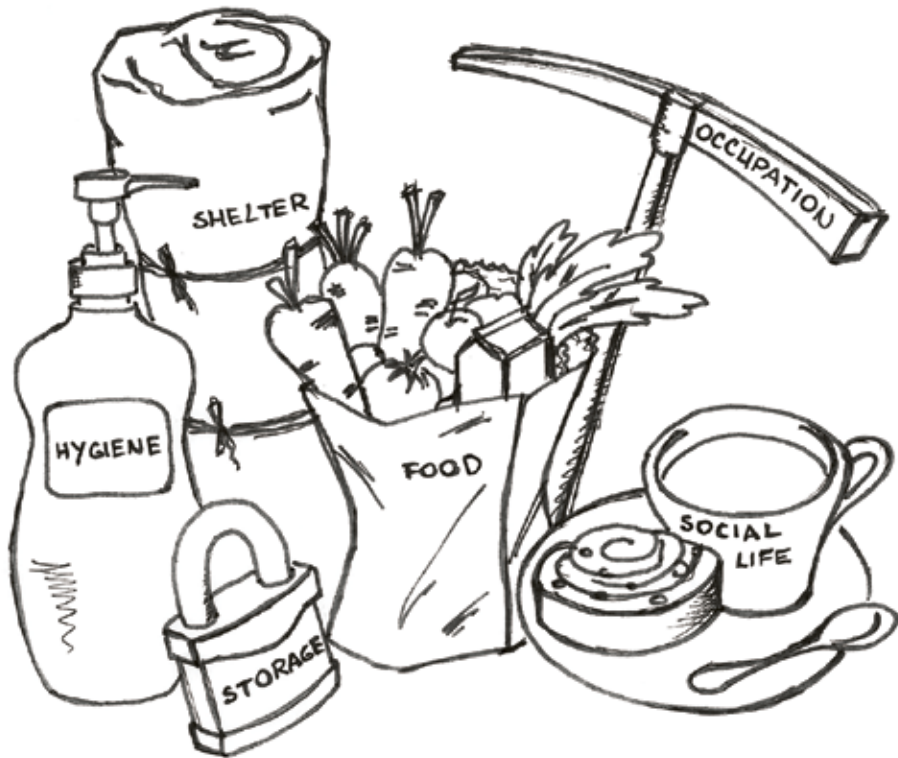

**OKSANA KOLBOVSKAJA:
URBAN POOR AND THE RIGHT TO THE CITY
– ALTERNATIVE SOCIAL HOUSING AND CITIZENSHIP MODEL**

This proposal aims to change the attitude towards homeless people in Stockholm from objects of shame towards neighbors with different lifestyle.

I develop a dissolved network of amenities fulfilling their basic needs on the islands of Södermalm, Kungsholmen and Långholmen and detail the hygiene aspect of this network. It will give them a chance to keep social bonds, access same resources and opportunities as other citizens and enhance possibility to change their situation.

Studio SUPD, supervised by:
JOHAN PAJU
BETTINA SCHWALM

Contact details:
o.kolbovskaia@gmail.com



KONSTANTINA KONSTANTINOOU:
RECOLOR
– *RESTRUCTURING THE CITY OF LIMASSOL*

The focus of the project is about restructuring the centre of Limassol in order to find new life lines and create friendly ways for pedestrians. The proposal presents a clear structure of a circular loop and six linear axes. The strategy in designing the loop and these lines is to highlight the unique qualities and different characters of specific locations. Together the loop and axis, will allow the inner-city to function more as a whole, in respect to live, work, culture, education and tourism.

Studio SUPD, supervised by:
MARIA GREGORIO
PATRICK VERHOEVEN

Contact details:
cotsia5@hotmail.com



YANG LUO:
SPONGE CITY
– *ECO PARK TO REDUCE FLOODING RISKS*

In recent years, due to climate change, Wuhan has been hit by heavy rains with severe flooding in summer, which has gradually evolved into a chronic disease. To reduce the risks of floods, the strategy of *Sponge City* is implemented by the government to make the city flexible to utilize rainfalls. The aim of this project is to explore how sponge body, which is the core of sponge city, could be constructed and function well by designing Qingling lake into an eco-park as a pilot site.

Studio SUPD, supervised by:
ÅSA DROUGGE
GÖRAN LINDBERG

Contact details:
yangluo.0815@gmail.com

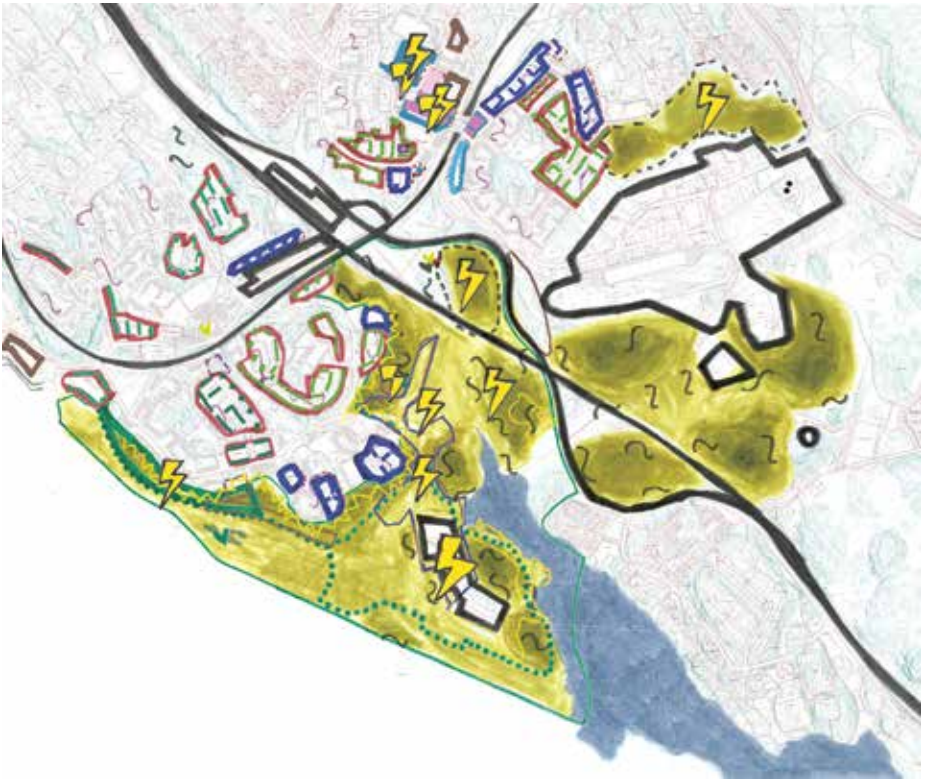

SARA MALM:
CONFLICTUAL COMMONS

Högdalen-Rågsved experiences a breakpoint of change which brings the definition of the ideal city and who is included or excluded to the negotiation table. Conflictual commons are the spaces used as common resources which becomes actualized for contestation.

With organized movements and walking experiences, I explore conflicts over commons and look into actors involved, what understanding of space they act from, where maintenance responsibility is put and which scales is perceived as relevant.

Studio SUPD, supervised by:
THÉRÈSE KRISTIANSSON
MARIA ÄRLEMO

Contact details:
sara_malm@hotmail.com



BRYANS MUKASA:
URBAN EATOPIAS
– THE FUTURE OF FOOD IN CITIES SHAPED BY IMMIGRATION

Urban Eatopias is based on the premise that food can be seen as ordering principle for cities – a tool to create productive, multifunctional and more liveable cities for everyone.

With Södertälje as Swedish case study, this project examines the potential of food as catalyst for sustainable urban futures in cities shaped by immigration. It seeks to create a spatial, organisational and social structure based on local production and consumption of food to foster the economic and social integration of immigrated citizens. In a sustainable vision of tomorrow *Urban Eatopias* allows food and eat-scapes to become the loom creating a desirable social fabric, a key element for sustainable urban planning.

Studio SUPD, supervised by:
JORDAN LANE
JOHAN PAJU
BETTINA SCHWALM

Contact details:
brmukasa.com
brmukasa@gmail.com

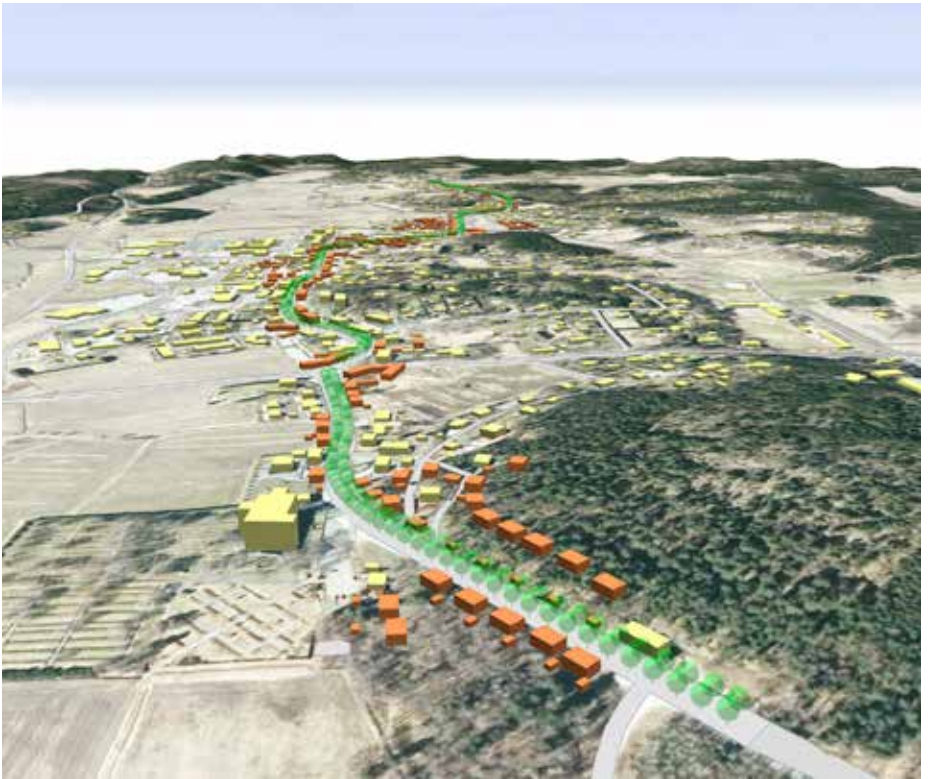

DENNIS SÖDERHOLM:
RURAL DENSIFICATION AND THE LINEAR CITY
– A THOUGHT EXPERIMENT

Densification of the urban structure is a hot topic in urban development, but densification is almost absent as a strategy in rural settlements. This project studies densification in a rural settlement in a Nordic context by using the “dense and low-rise” design strategy and the concept of linear cities. Is linearity the key to rural densification? The concepts are tested on the small town of Kimito in south-western Finland.

Studio SUPD, supervised by:
ÅSA DROUGGE
GÖRAN LINDBERG

THE JURY: **JANUARY 12-13:**

LISE-LOTT SÖDERLUND

Lise-Lott Söderlund (Stockholm, SE) works as Chief Architect and Vice President of BSK Arkitekter AB. She is in charge of BSK Arkitekters development and progress in the field of architecture, both in terms of working methods and in the final products the office provides. She leads the work to improve sketch and analysis methods, conceptual skills and the architectural quality of the buildings, interiors and urban spaces that BSK Arkitekter designs.

After studying architecture at KTH, Stockholm, Lise-Lott's career made a flying start in 2000 when she was the lead architect of BSK Arkitekters winning entry in the international architectural competition for the Swedish Post headquarters. The three following years she was in charge for the design of the 60.000 sq.m. building in Solna, nominated for the Kasper Salin Prize when it was completed. Lise-Lott received the award Successful Leader in the Construction Sector by CMB at Chalmers.

In her profession, Lise-Lott has developed a pragmatic approach where the brief and the final client requirements are the main generators in the design process in combination with technical, financial and production aspects from the initial stages in the projects. This is a subject that she frequently teach Developers at Stockholm School of Economics Executive Education.

BOLLE THAM

Bolle Tham (Stockholm, SE) is co-founder of Tham & Videgård Arkitekter. Since the start in 1999 the practice has attracted attention for its experimental approach and innovative built works. Tham & Videgård's projects has won several national and international awards, most recently the Kasper Salin Prize 2015 for the new KTH School of Architecture in Stockholm.

Other major works include the Kalmar Museum of Art (Kasper Salin Award 2008), the Moderna Museet Malmö (for the Swedish Museum of Modern Art), the Tellus Nursery School, the Uppsala Department store, the Archipelago house, the House Lagnö, the Creek House, the Apartment Humlegården and the Tree Hotel in Harads. Bolle Tham also teaches and lectures at schools of architecture in Sweden and abroad. In 2014-2015 he was guest professor at the PBSA Peter Behrens School of Architecture in Düsseldorf, Germany. Tham & Videgård have lectured at the Netherlands Architecture Institute, ETH Zürich, the Architectural Association in London, at Harvard GSD and at the IIT in Chicago.

Bolle Tham studied architecture at the KTH School of Architecture 1991-97; École d'Architecture de Paris-Belleville 1994-95; ILAUD in Italy 1995, and a Postgraduate in Architecture at the Royal Institute of Art in Stockholm in 1998-99.

MALIN ZIMM

Malin Zimm (Stockholm, SE) is an architect PhD, and currently employed as Research and Analysis Strategist at White arkitekter. Malin Zimm was engaged as Senior Advisor in Architecture at ArkDes (the Swedish Center for Architecture and Design) between 2010 and 2014. From 2007 until 2009, she was Editor-in-chief of the architecture magazine Rum.

Malin Zimm completed her doctorate studies at the KTH School of Architecture in 2005 with the thesis *Losing the Plot – Architecture and Narrativity in Fin-de-Siècle Media Cultures*, investigating pre-digital virtual architectures as found in literature and early cinema from late 19th Century. Zimm is a contributor to Swedish and international architecture magazines and publications since 1999, most recently with an essay about fan fiction and fan culture in relation to architecture, in *Breaking and Entering – The Contemporary House Cut, Spliced, & Haunted* (ed. Bridget Elliott, McGill-Queen's University press, 2015).

Malin Zimm's research interests include the development of the subject of architecture in relation to society, culture, technology and media.

Sessions held in Swedish and English, hosted by:

ELIN STRAND RUIN
*University Lecturer,
KTH School of Architecture*

**ARCHITECTURE DEGREE PROJECTS:
PRESENTED ON JANUARY 12-13**

Architecture Degree Projects by:

FRIDA ALEXANDERSON
ANNA HOFFMAN
VILIUS JUKNEVICIUS
ELSA KRISTINA SUNDIN
JOSEFIN LINDBLOM
ASTRID LINNÉR
PONTUS LJUNGBERG
EMMA MOLITOR
TOBIAS NORENTSTEDT
ANDREAS NYSTRÖM
MATILDA SCHUMAN
MY SIVESSON
ALEXIA STAAF
HJALMAR WEDHOLM

External Jury:

LISE-LOTT SÖDERLUND
BOLLE THAM
MALIN ZIMM

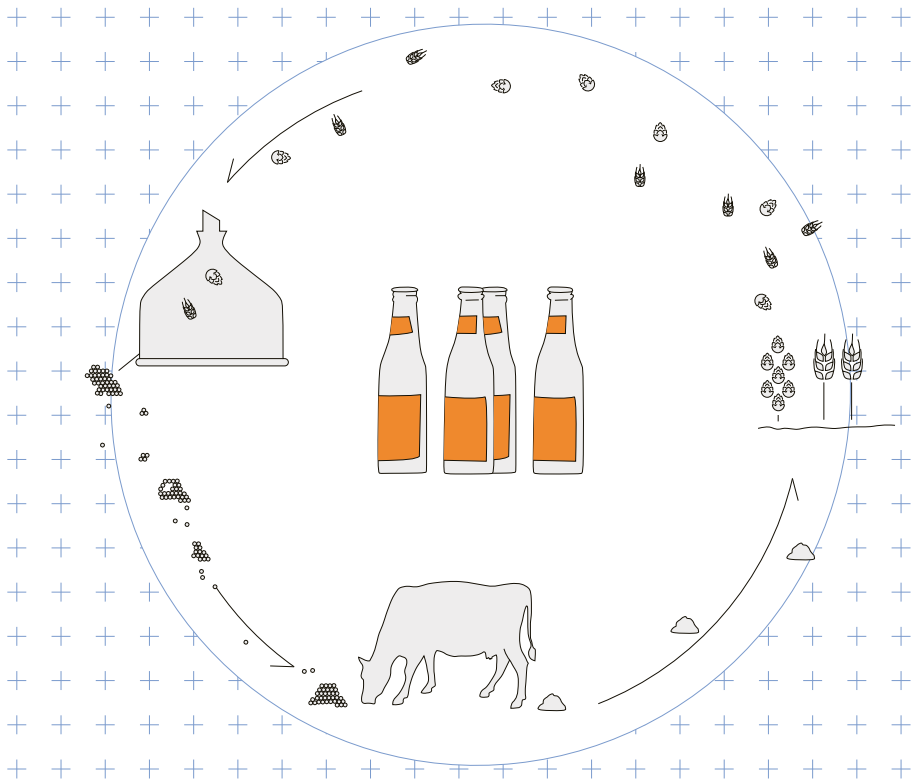

**FRIDA ALEXANDERSSON:
BRYGGERIGÅRDEN – BREWMASTER SCHOOL ON NORTHEN ÖLAND**

Two months every summer Öland is coming to life when thousands of tourists are visiting the island. The rest of the year it is half asleep. The season is too short to create a viable society all year round and the service provided is decreasing for the residents.

In this project my aim has been to investigate if architecture combined with a relevant program can attract new groups of visitors to the island independent of the season, and strengthen the identity of a small community.

Studio 6, supervised by:
LEIF BRODERSEN
TERES SELBERG

Contact details:
aog.se
fridaalexanderson@hotmail.com



VILIUS JUKNEVICIUS:
DIGITAL DESIGN & FABRICATION
– WITHIN TECHNICAL AND ECONOMICAL LIMITATIONS

Today, designing in digital environment is far less limiting than in actual reality – Forces, physical material properties, manufacturing limits and etc. are yet not present most of our digital design tools.

In this particular thesis project we concentrate on the restrictions from the fields of manufacturing and assembly. The key is not only in taking in these restrictions, but use them as a starting point and pushing them to their limits to produce innovative designs.

Studio g, supervised by:
KAYROKH MOATTAR
JONAS RUNBERGER
ELSA WIFSTRAND

Contact details:
Viliusjukne@gmail.com

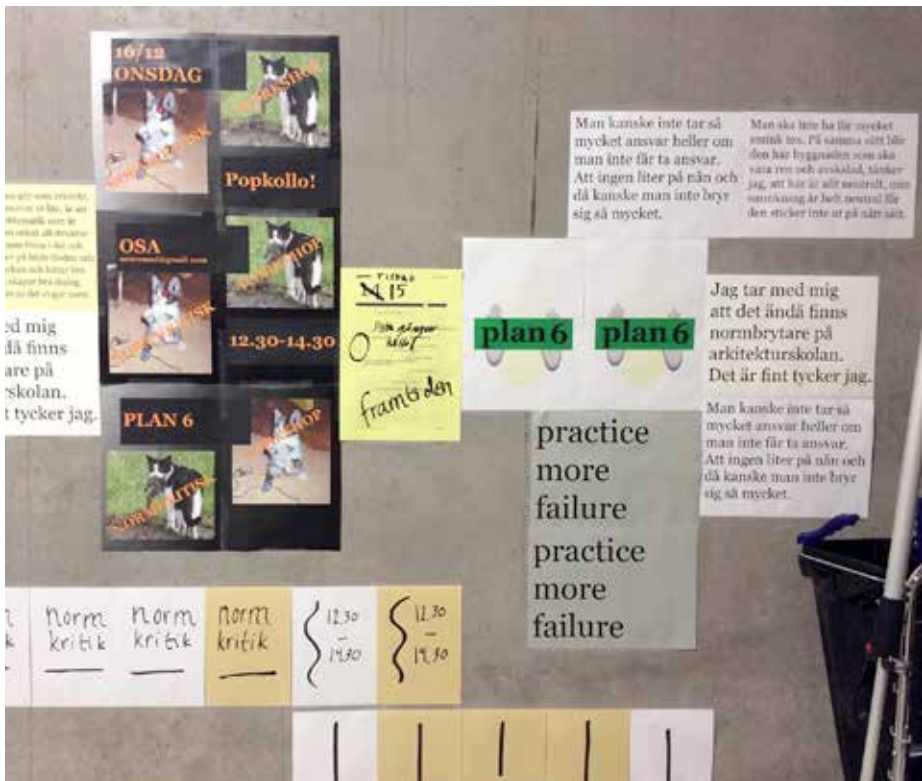

**ELSA KRISTINA SUNDIN:
SECOND OFFICE**

This project is discussing the issue of the production of architecture. What are we really doing? How are we working and what is at stake? What are the consequences? Is it possible to find answer to that question by focusing on the new school of architecture and thoughts that the new building evokes? I am using the new school as a surface to project my issues upon. I am making a sketch of an occupation. I am curating a series of talks on level 6 to pin down the norm and what we take for granted.

Studio 2, supervised by:
TOR LINDSTRAND
ANDERS WILHELMSON

Contact details:
[facebook.com/dromfakulteten4ever](https://www.facebook.com/dromfakulteten4ever)



**JOSEFIN LINDBLOM:
A NEW FERTILITY CENTRE AT SOPHIAHEMMET**

While assisted reproduction techniques enable previously infertile people to have biological children, undergoing fertility treatments is often a demanding and emotional experience. This project investigates how architecture can complement the medical treatment by meeting the patients' individual needs of comfort and encouragement throughout their process.

Studio 6, supervised by:
LEIF BRODERSEN
TERES SELBERG

Contact details:
sarajosefinlindblom@gmail.com

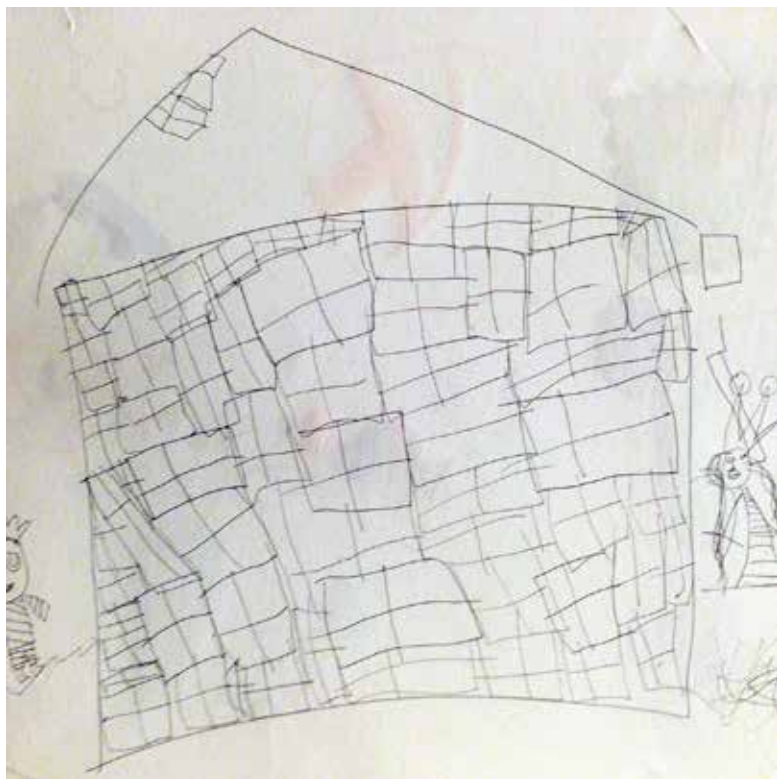

**ASTRID LINNÉR:
*FROM SISAB TO MONUMENT VALLEY***

Children experience the room and relate to it with their movement, body and senses. Architecture is for them a body language. I have wanted to create an architecture that builds on an actual reality, with a real place and real conditions, but that also allows itself to push the limits and meet children in their boundlessness. To put focus on and emphasize the children, the protagonists, which I think is neglected in today's architecture. It's about more than just a storage of kids, it's about maintaining and nurturing their curiosity and enthusiasm for life.

Studio 6, supervised by:
LEIF BRODERSEN
TERES SELBERG
ELIN STRAND RUIIN

Contact details:
astrid.linner@gmail.com



**PONTUS LJUNGBERG:
*WALLS BARRIERS BORDERS***

This project contains an investigation into walls, barriers and borders and a method of using this vast amount of data to generate new knowledge and examples of walls. The project discusses a broad selection of questions on what a wall is, how modern urban barriers function, as well as the use of national fortifications and more. This investigation, method and newly acquired knowledge are all compiled in a book with the same title as the project.

Studio s, supervised by:
JOHAN PAJU

Contact details:
ljungberg@post.com

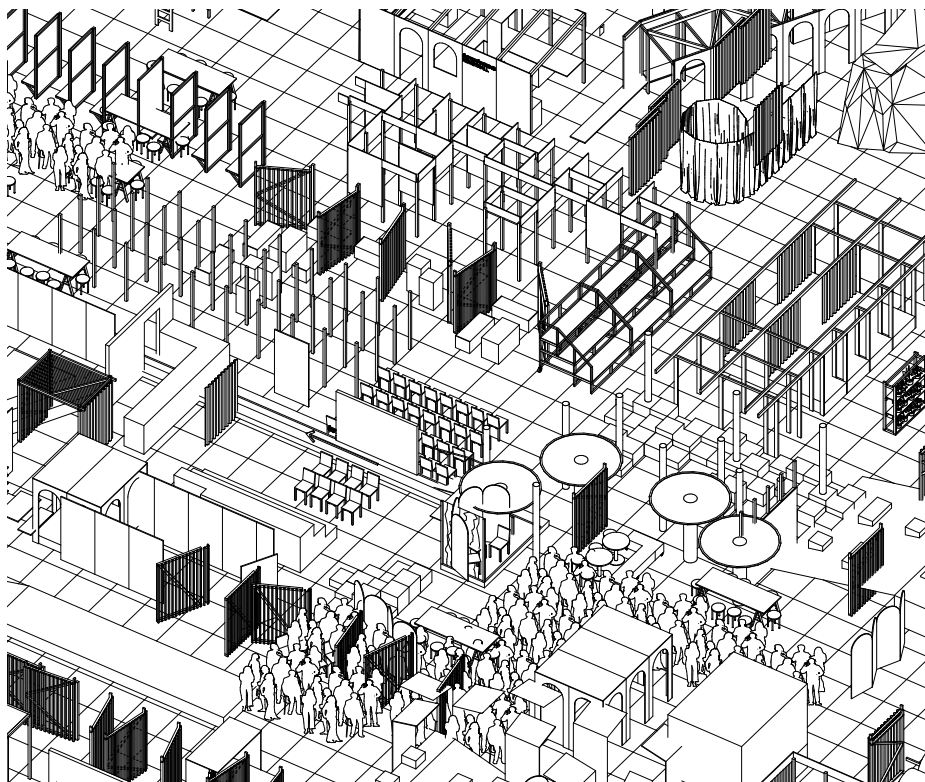

**EMMA MOLITOR:
*TORGET, BERGET OCH DEN VITA KUBEN***

The project is about a recently established art gallery in Österängen, a suburb to Jönköping. The main interest concern how spaces for contemporary art function and are created today. My design for Österängens art gallery is a sequence of specific environments that refers or contrasts to the white cube, the norm, and is investigating the correlation between contemporary art and architecture. The art gallery is not passive; it is an active actor in producing and selecting the art exhibited.

Studio 2, supervised by:
TOR LINDSTRAND
ANDERS WILHELMSON

Contact details:
emma.helen.molitor@gmail.com



MATILDA SCHUMAN:

ADDITION

– ALTERATION & EXTENSION OF WEBSTER SCHOOL IN SEATTLE

The aim of my thesis project has been to carry an existing building from the past into the present and to create a meaningful dialogue between old and new. I have seen the existing as a source of inspiration and knowledge, and my proposal consists of interventions that aim to both strengthen the spatial qualities of the existing, and to extend the atmosphere into my proposed extension. My work also aims to add new ways of experiencing the existing building, to create a new, stronger ensemble of spaces.

Studio 10, supervised by:
ALEXIS PONTVIK
INGRID SVENKVIST

Contact details:
matildaschuman.se
matilda@schuman.se

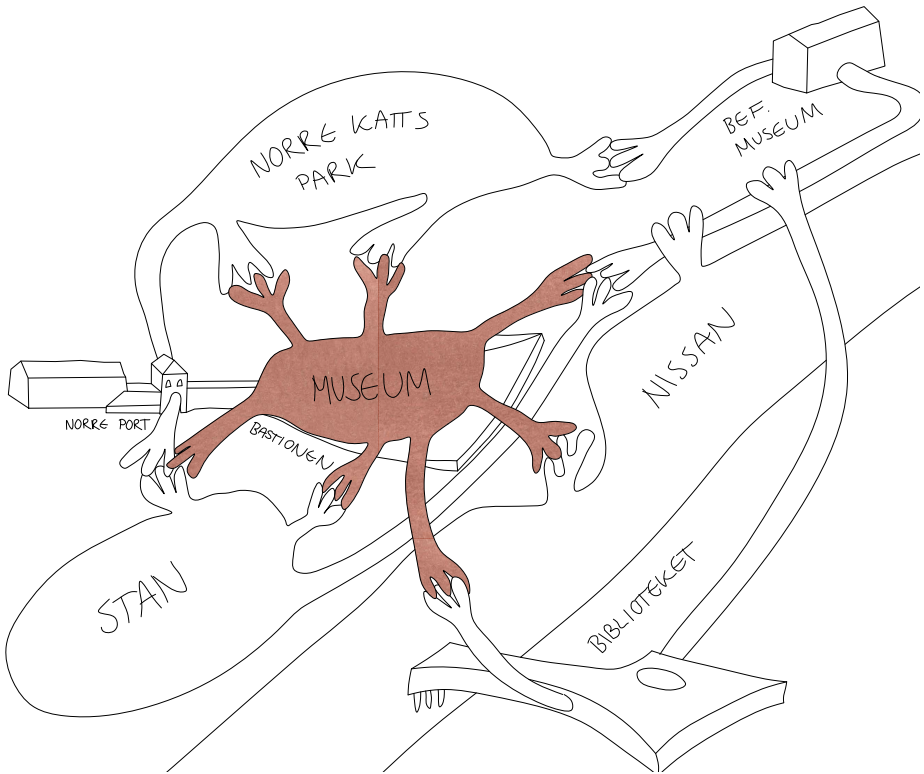

MY SIVESSON: MUSEUMPROMENADEN

Hallands Konstmuseum has grown out of its existing museum building and is now planning a renovation and an addition to the museum. By thinking of the museum as a public space in the city, instead of a place just for the regular museum visitor, the project investigates what a museum can be in Halmstad.

Studio 1, supervised by:
JOHAN PAJU

Contact details:
mysivesson@gmail.com



ALEXIA STAAF:
SPATIAL EVOLUTION IN YANGGEZHUANG VILLAGE, CHINA

At first, the village seems unchanged despite the rapid development of recent decades. Streets of enclosed courtyards and dusty roads are surrounded by farmlands and mountains. But as the closed courtyards open up there is a dramatic contrast between traditional rural dwellings and the construction of new family homes. The journey is set out to investigate the processes of transformation through fieldwork and documentation.

Studio 2, supervised by:
TOR LINDSTRAND
ANDERS WILHELMSON

Contact details:
alexia@kth.se

**KTH-A 2015-2016:
STUDIO THEMES**

STUDIO 1:

FULL SCALE

ANDERS BERENSSON
EBBA HALLIN
JOHAN PAJU
MALIN ÅBERG-WENNERHOLM

STUDIO 2:

***WORKPLACE, LABOUR AND
EVERYDAY LIFE***

TOR LINDSTRAND
KARIN MATZ
ANDERS WILHELMSSON

STUDIO 3:

'LAGOM'

JOHAN CELSING
JOSEF EDER
CARMEN IZQUIERDO

STUDIO 4:

***ARCHITECTURE FOR
EXTREME CONDITIONS***

CHARLIE GULLSTRÖM
PABLO MIRANDA CARRANZA
ORI MEROM

STUDIO 5:

FICTIONS

ULRIKA KARLSSON
CECILIA LUNDBÄCK
EINAR RODHE
VERONICA SKEPPE
CLAES SÖRSTEDT

STUDIO 6:

SEARCHING FOR MA

LEIF BRODERSEN
TERES SELBERG
CHRISTIN SVENSSON
HELENA PAVER NJIRIC

STUDIO 7:

UNNAMEABLES

ELIZABETH HATZ
PETER LYNCH

STUDIO 8:

A COMMON URBANITY

SARA GRAHN
RUMI KUBOKAWA
MAX ZINNECKER

STUDIO 9:

ARCHITECTURAL INFRASTRUCTURE

KAYROKH MOATTAR
JONAS RUNBERGER
JULIEN DE SMEDT
ELSA WIFSTRAND

STUDIO 10:

GLOBAL CONNECTIONS

ALEXIS PONTVIK
INGRID SVENKVIST

STUDIO SUPD:

DIY URBANISM

ÅSA DROUGGE
JORDAN LANE
GÖRAN LINDBERG
BRYANS MUKASA
JOHAN PAJU
MEIKE SCHALK
BETTINA SCHWALM

ADVANCED LEVEL STUDIES AT KTH-A: STUDIO THEMES & DEGREE PROJECTS

THE DEGREE PROJECT

The Diploma Days marks the finalization of studies at Advanced Level at the KTH School of Architecture. The Advanced Level consists of 2 years of study and includes a Degree Project, which is carried out in the final term. After its completion, students may be awarded the Degree of Master of Architecture or the Degree of Master of Science (120 credits) with a Major in Architecture, depending on whether they are enrolled in the 5-year Degree Programme in Architecture or the 2-year Master's Programme in Architecture.

THE STUDIO SYSTEM

Our teaching is structured around a studio system, meaning that groups of students join up with tight-knit teams of teachers to embark on their studies as a shared undertaking throughout the academic year.

Students develop a theme or research interest through group work as well as through individual projects. Each studio is structured around distinct pedagogical approaches, each of them addressing their own specific topic of interest.

The KTH-A offers 10 different Advanced Level studios for the 2015-2016 academic year. In addition, students have the possibility to enter the Sustainable Urban Planning and Design programme (SUPD) studio for one year, while still being able to graduate

from the architecture programmes. You can read overviews of the KTH-A Studio Themes for 2015-2016 in the following pages, as presented to the students during the start of the academic year in September. For a more in-depth presentation of the themes, see the *KTH-A 2015-2016* catalogue (available in print and online) and the wall posters in the KTH-A entrance foyer.

ARCHITECTURAL EDUCATION AT KTH

Beyond the programmes at Basic and Advanced levels, the KTH School of Architecture offers an architectural education that spans a range of additional levels: it provides a foundation year – based in Tensta in north-western Stockholm – and independent courses, as well as a PhD programme.

Detailed information about studies at the KTH-A is found at www.arch.kth.se.

ANDERS JOHANSSON
Head of the KTH School of Architecture
PER FRANSON
Head of Education
FRIDA ROSENBERG
Head of Advanced Level Studies

MALIN ÅBERG WENNERHOLM
Architecture Program Director
MEIKE SCHALK
SUPD Program Director

Below: Studio Themes intros, Aug 31 2015



STUDIO 1: FULL SCALE

STUDIO THEME

The primary focus of Studio 1 is to test new ways to approach and create architecture. We believe that there are many unexplored parts of our profession and that the most beautiful, functional, affordable, fair, breath-taking, godlike, sustainable, and amazing buildings have not yet been built.

Studio 1 attempts to reach higher through a straightforward and fairly unexplored method: to design and build. To design something and then just do it, to continue designing while doing it, and to constantly make improvements throughout the whole process, going beyond representations and simulations. To make material perform in ways it never knew it could, to play architecture just like a guitar or like football. Studio 1 is a study in making, an investigation of building processes.

By jumping right into the game, we feel and see all factors directly, we meet actors and review customs, we encounter allies and opponents, and we gain an understanding of the field. We come to know when and why we need drawings and renderings, and we to try every muscle that is needed to make buildings. In this, we experience the potential of and barriers to making the architectural masterpieces of tomorrow.

The studio's aim is not to adapt to the current conventions, but to investigate and improve contemporary building

practices, from material use to politics, for the sake of architecture. Being part of an academic context, we have a great amount of freedom to do so, and a liberating lack of money, which keeps us focused and inventive.

TEACHING METHODOLOGY

By taking an active part in building processes at various scales, students will gain personal experience and a better knowledge of the production chain, encountering constructions in real-time, rather than through simulated cases. Structural durability, materiality, and detailing become unavoidable topics early on, rather than last-minute additions. Relations between resources, site, architecture, craft, and mass-production are exposed, feeding back into a critical approach and ultimately generating a more confident conceptual focus. The idea is to be a player before becoming a coach.

During the year, students learn about architecture with their eyes, ears, and hands. Design tools will be tested in real time, at 1:1. We believe that working in groups makes students reach further, learn more, and be braver. Projects will be analysed by actually being in them and testing them for real. Studio 1 is a collaborative ongoing research project. We will meet last year's students and visit their projects, discussing intention in relation to outcome, use, and durability.

Studio 1 2015-2016 taught by:
ANDERS BERENSSON
EBBA HALLIN
JOHAN PAJU
MALIN ÅBERG WENNERHOLM

Below: The workspace that the studio designed and constructed on the KTH Campus in 2014. It consists of two non-permit building types, an "Attefallshus" and a "Friggebod", where the latter can slide on railway tracks to form one large or two separate volumes.



STUDIO 2: WORKPLACE, LABOUR AND EVERYDAY LIFE

STUDIO THEME

If the contemporary city can increasingly be seen as an integrated extension of an overarching marketisation of society and a shift from politics to economics, then neighbourhoods like Fittja, Alby, Hallunda, and Norsborg stand as physical reminders of a different society.

Since the spring of 2013, the studio is working in collaboration with Botkyrka municipality on a series of projects in the neighbourhoods of northern Botkyrka. These residential areas were all primarily constructed as part of the Million Program and have, since their completion in the mid-seventies, been heavily criticised in mainstream media. Late-modernist architecture and planning marked a paradigm shift in the history of Swedish architecture, which remains a reoccurring topic in almost every discussion about architecture and planning today. This year, the studio will concentrate on projects related to 'work'. In the 1967 General Plan for these neighbourhoods, over 10,000 workplaces was envisioned, however these failed to materialize and today most people commute over long distances to get to work. Together with the municipality of Botkyrka, Botkyrka art centre, local organisations, and other art and architectural education institutions, we will map the current forms of the workplace and labour in order to make architecture and planning proposals that

address the lack of job opportunities within the area and at the same time imagine how work can be organised in the future.

Whilst the projects are down-to-earth and straightforward, the overall theme engages with difficult questions regarding the future of late-modernist communities, politics, the organisation of everyday life, and the role that architecture can play in counteracting a segregated city.

TEACHING METHODOLOGY

Studio 2 focuses on the social dimension in architecture. We are less about what architecture looks like and more oriented towards what architecture *does*, what it *performs*.

A design process is not merely about finding a method to create an object, but about engaging in the complex and contradictory field of relationships that inform our making and understanding of the built environment. It is about introducing questions and uncertainties right before consensus is established: about what we architects do and how we do it. Rather than a collection of tools, methods, vantage points, and positions, the aim of a design process is to question and reflect upon the fundamental conditions of what constitutes a contemporary architecture practice – to unravel the very ground on which we stand.

Studio 2 2015-2016 taught by:
TOR LINDSTRAND
KARIN MATZ
ANDERS WILHELMSON

*Below: 'The Vegetable Program' exhibited
at the Multicultural Centre in Fittja in the
summer of 2015*



STUDIO 3:

'LAGOM' – THE ESSENTIAL WITHIN THE MUNDANE

STUDIO THEME

The studio work in the 2015-2016 academic year is framed by the concept "lagom". This term, or position, is often spoken of with irony in Sweden. *Lagom*, it seems, is ridiculed as a position lacking radicalism or a vigorous spirit. In fact, this concept denotes profound philosophical issues central to the intellectual and moral history of the western world. *Decorum* is a related concept elaborated on by, among others, Aristotle in the 4th century BC. "The appropriate" is a contemporary term for this concept.

As we know, what is appropriate to a certain aim, or to a certain context may be erroneous in another. However, what is crucial is how the project fulfills its aims, and relates to its physical or circumstantial context. Thus, we expect student projects to range from the elementary to the fantastic.

The shape and conditions of 'the public' and 'the private' are subject to constant redefinition and adaptation as society evolves. The redefinition of our ways of living affects, and is materialized in, architecture. The challenge of giving shape to our surroundings in this state of flux calls for a thorough understanding of the tools of architecture and of the forms of the past to be able to imagine the buildings of tomorrow.

TEACHING METHODOLOGY

The aim is that students forge architectural solutions ranging from the detail to the whole. To keep the visual appearance of buildings (so dear in our contemporary culture) at a distance, the initial assignments will focus on the parts, the details, as protagonists in the architectural designs.

The detail as necessity

The detail as an invisible but tactile reality

The detail as a creator of atmospheres

The detail as a sign of an attitude

The detail as part of a family of tectonic solutions

To deepen our understanding of the nuances of buildings, of the role of the parts in the whole, we will make a measuring survey of an extraordinary 20th-century building. To provide the design task with an overview, we will make case studies of a selection of related buildings. The design work will elaborate the contemporary issues that pertain to the chosen sites and programs.

Studio 3 2015-2016 taught by:
JOHAN CELSING
JOSEF EDER
CARMEN IZQUIERDO

Below: View of garden pavilion on the Philopapou Hill, Athens, Greece, by Dimitris Pikionis



STUDIO 4: ARCHITECTURE FOR EXTREME CONDITIONS – FROM SAMI TO OSTUNI

STUDIO THEME

Studio 4 seeks to push the boundaries of what architecture *is*, by exploring what architecture *can be*. We will continue developing the theme that we initiated last year, however with a slightly different approach. We begin the year by designing a Nature Experience Centre (“Naturrum”) for Sami culture in the vast and beautiful landscape of the far north in Sweden. Then we move from north to south (and from rural to urban) in order to design for public space transformation in Ostuni, Italy. Here, we will be challenged by a completely different setting, an extreme environment shaped by geology and a hot climate, in the historic Apulian region of Valle d’Itria.

As per previous years, we remain interested in the concept of materiality in architecture. As a basis, we approach this from a Bauhaus perspective, asking students to use their eyes and hands to see and represent an architectural experience. To meet the challenges of global warming and our planet’s limited resources, we are also interested in what researchers from different fields are developing in terms of new materials and technologies. These innovations can be applied to architectural design and we therefore ask students to try them out. What are their qualities and how do they compare to traditional materials in architectural design,

such as stone, wood, glass, and steel? In short, the studio explores new materials that are applicable to extreme living conditions in order to make this planet a better place.

TEACHING METHODOLOGY

At Advanced Level, students already have an individual approach to their design thinking. Our view is that although architectural training has equipped them with various design tools and methodologies, they still need to sharpen their personal artistic voices. It is our job in the studio to help our students mature, step by step, by scrutinising design intentions in a way that allows students to position themselves in a broader context—always facing the challenges of our future society. We want to ensure that the Degree Project becomes a personal landmark and a springboard for students’ future careers as architects. For this reason, we sometimes make slight adaptations of the course design, allowing our 5th-year students to work in preparation for their Diploma Degree Project.

At the Diploma Days in June 2014, Studio 4 was awarded the Jury’s Mention in recognition of our teaching methodologies and the way we coach our students to take risks (even in the last term), encouraging them to formulate design problems outside the conventions of architecture.

Studio 4 2015-2016 taught by:
CHARLIE GULLSTRÖM
PABLO MIRANDA CARRANZA
ORI MEROM

Below: The exhibition 'Another Earth', produced by the students in Studio 4. The winning pavilion from the 'Inspired-by-space competition', by Studio 4 student Stefania Dinea, was erected inside the Dome of Visions on KTH Campus in the summer of 2015.



STUDIO 5: FICTIONS

STUDIO THEME

'...truth, whose mother is history, rival of time, depository of deeds, witness of the past, exemplar and adviser to the present, and the future's counselor.'¹

The author Menard, according to the narrator of the story, defines history not as an inquiry into reality, but as the source of reality. "Historical truth, for him, is not what has happened; it is what we judge to have happened."²

This year, Studio 5 will further last year's theme, *translations*, and engage in *fictions* – architectural fictions. Fictions imply the fabrication or construction of histories or narratives. The studio will explore different connections between translations and fictions; modes and technologies for their fabrication; and their relationships to history, architectural history, time, the present, and to future projections. Through the sequence of projects *material fictions*, *local fictions* and *architectural fictions* the studio will involve processes of architectural documentation, reuse and scenario-making.

Throughout the year, we will work with robots in architecture, both as tool for fabrication (Project 1 & 2) and in relation to automation and its impact on our society (Project 3 & 4). Fictions will be addressed from various perspectives: materialised in an architectural design or methodo-

logically as a way of imagining future scenarios or retelling fictions of the past.

TEACHING METHODOLOGY

How we work affects what we produce. Studio 5 will continue its interest in the development of rigorous design research, and will establish new ways of thinking about the negotiation between digital and material processes for design and fabrication, theory and history, professional practice, teamwork and the cultural impact of contemporary architecture. Through iterations of drawings, models, and 1:1 scale prototypes, students will develop design techniques and sensibilities, enabling the design of innovative architectural proposals. Contrary to a linear design approach where technological processes are applied in the interest of optimisation, this studio adopts a bi-directional approach where technological processes are incorporated as drivers of design innovation. Through design, the students' work will contribute to contemporary architectural discourse and its dialog with society, art, and aesthetic theory.

1: Borges, Jorge Luis, 'Pierre Menard, Author of Don Quixote', 1939, translation Irby, James E. 1962

2: *Ibid.*

Studio 5 2015-2016 taught by:
ULRIKA KARLSSON
CECILIA LUNDBÄCK
EINAR RODHE
VERONICA SKEPPE
CLAES SÖRSTEDT

*Below: Five-axis robot at Konstfack.
(photo by Einar Rodhe)*



STUDIO 6: SEARCHING FOR MA – INVESTIGATIONS OF SPACE AND TIME

STUDIO THEME

We will study how different interdisciplinary artistic tools and methods can be transformed into architectural design processes, creating new kinds of spatial platforms for sound experiments in Stockholm. Then we will investigate an area of UNESCO heritage in the beautiful but depopulated context of Hvar in Croatia. We will work with a mixed-use programme linking present to past through sustainable typologies and design interventions. Excursion to Split and Hvar are scheduled for October 24-31. The third studio project will focus on *specificity* and *narrativity*—students will create a story about a real or fictive person as a foundation for the development of a very specific design for a very specific home. The last project investigates what we can learn from the Japanese context, examining diversity, differentiation, metabolism, interactivity, flexibility, and conceptions of space and time (at the urban scale as well as in smaller scales). Based on studies of the relation between filmmaking and architecture, we will design a Film Studio Residence within the urban fabric of Tokyo. In March-April the studio plans a trip to Tokyo, where we have developed contacts with Atelier Bow-Wow, Tezuka Architects, SANAA, Junya Ishigami, Tetsuo Kondo, and Tokyo Institute of Technology.

TEACHING METHODOLOGY

This studio investigates different experiences of architecture and conceptions of space in relation to the synthesizing design process. We explore basic architectural concepts such as gravity, emptiness, speed, light, sound, colour, tactility, etc. We have developed a methodology wherein students and teachers collaborate in a kind of research-by-design structure. The students define and formulate their own projects from a given topic and self-program their projects to reflect on the problems and possibilities described in the analysis and definition of the context. The aim is to provide tools and methods in order to give the students an independent, innovative, artistic, professional, ethical, and scientific identity. Every project is specific and independent, but also relates to the general theme. We think it is important to work with different topics, problems, and scales at the same time. Every project starts with a group research phase – collecting relevant theory and information, defining the different options, and understanding the context. Students discuss, evaluate, reflect, and make decisions. We want them to feel involved in a larger overall research-by-design movement, where the parts and projects are important but where the research outcome as a whole—and the multitude of different approaches and projects—is the most important.

Studio 6 2015-2016 taught by:
LEIF BRODERSEN
TERES SELBERG
CHRISTIN SVENSSON
HELENA PAVER NJIRIC

*Below: Step notification, an investigation
of sound and space.*



STUDIO 7: UNNAMEABLES – FRAGMENT AND COHERENCE

STUDIO THEME

Architecture is a play of regularity and contingency, clarity and ambiguity, rationality and instinct, freedom and accident. Contingencies of site and program recast and reshape the a-priori intentions of the architect. The search for an architectural solution never begins as a *tabula rasa*, but rather with a palimpsest of half erased or altered traces. To unravel and re-assess these layers is part of a creative projective process. We take an interest in both established and potential architecture, in deliberate and accidental choices, in design as a process of coming-into-being. Our starting point this year will be the region between the rational and irrational: what Irish writer Samuel Beckett calls a zone of semi-consciousness, “forms without parallel”. This is a place where *study* and projective *speculation* fuse and feed each other. From this starting point students will follow two paths: uncovering an own idea of a particular architectural *modus*, an own architectural direction; and developing a singular, idiosyncratic, highly contingent work. The world of built rooms, interior and exterior, where we seek our models, is a realm for interaction, confrontation, and musing. The trip this year is to Ireland and Dublin – where architecture and landscape meet literature in a unique way. We will explore remarkable buildings and places and meet Irish architects and architecture programs.

TEACHING METHODOLOGY

Accumulated archive – study and speculation. The studio will build an archive of knowledge and projects in the form of studies, speculations and designs. This collective inventory, organized in *territories of research*, will be exhibited and discussed with an extended audience inside and outside the school. The process will draw on seminars and fieldwork. Hand-drawing, physical model-making, material exploration, and development of craft skills will be paramount concerns.

Students are required to complete 1-2 pages of readings and participate energetically in the discussion each session for fortnightly seminars. The seminar will convene in different locations throughout the city. The first seminar is ‘The Night’, the second ‘Myth of Progress’.

This year we will explore the city of Stockholm through fieldwork—sketching and photographing, uncovering the city’s “forgotten architects”.

At end of each semester, studio work will be presented in a public exhibition. Participation in layout, logistics, installation, and de-installation is part of the course.

Studio 7 2015-2016 taught by:
ELIZABETH HATZ
PETER LYNCH

*Below: Cast-plaster model, Palatin vaulting,
Frida Körberg Turhagen, for Studio 7 'Choisy'
project in 2014.*



STUDIO 8: A COMMON URBANITY

STUDIO THEME

'Asserting the value of incomplete form is a political act architects should perform in the public realm. This means asserting not only the beauty of unfinished objects but also their practicality. It is a political act because it confronts the desire for fixity; it asserts, (...) that the public realm is a process.'

– Richard Sennett

This year, Studio 8 will explore the concept of a common urbanity. At varied speeds cities are in transformation, be it a process of becoming sustainable or the need to sustain itself. A new type of urbanity is forming in cities that may be a result of many tipping points, where social production responds directly to the various needs of their territories, from the urgency of providing for basic physical needs of housing to the creation of new kinds of cultural and social spaces. The individual has gained unprecedented importance because of their role amongst the many, with their connectedness their most important asset. At the same time, having shifted to the east, modes of production and manufacturing promote greater and greater independence from geographical location. In this context, we would like to re-consider the city and re-invent it as the space of production for the future, of forms of manufacturing products and of the artistic production of culture that can inform and construct the collective.

TEACHING METHODOLOGY

Studio 8 is supported by three teachers with different experience and expertise who offer students a wide field in which to test and reflect their ideas. We focus on the development of each individual student rather than a specific methodology and ask students to formulate their personal design strategies and to position their projects within the contemporary architectural discourse. Students are encouraged to examine the relationship between architectural design and environmental performance, with the opportunity to go deeper into specific questions within the context of the studio. We will introduce components of sustainable design through a series of seminars, providing the critical basis for design research and practice. Research and development is an important part of the studio culture in order to enable each student to formulate critical and relevant design questions. Collaboration with a range of experts in the field will help students develop interdisciplinary, integrated design strategies in the search for innovative sustainable design.

Studio 8 2015-2016 taught by:
SARA GRAHN
RUMI KUBOKAWA
MAX ZINNECKER

Below: 'Urban Incision São Paulo', a collective site model produced by students in Studio 8 2014-2015.

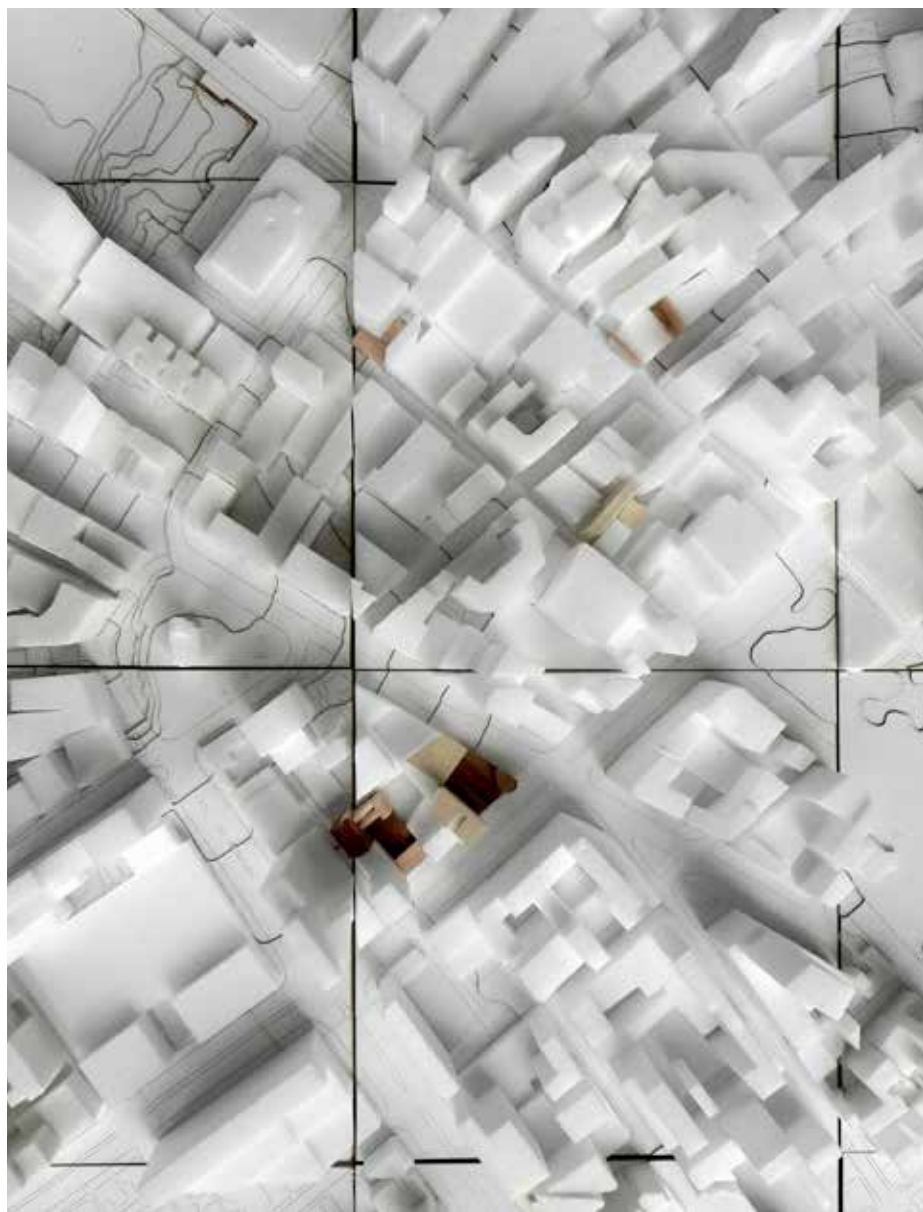

STUDIO 9: ARCHITECTURAL INFRASTRUCTURE – ADDRESSING STOCKHOLM’S GROWTH

STUDIO THEME

Stockholm faces a drastic challenge in the next 15 years: to house half a million new inhabitants. This condition presents Stockholm with the possibility of overtaking London as the fastest growing city in Europe. It also, however, raises serious questions regarding how our profession will approach this challenge and how we will take part in shaping the future of Stockholm, the largest Scandinavian metropolis.

Addressing large-scale development through a pragmatic and environmental approach, we will propose research and projects that aim to combine infrastructural needs with architectural out-comes. We will study and design new ways to connect the tremendous efforts (and expense) currently being made in the infrastructural sector with the building sector in an attempt to redefine “urban development”.

If infrastructure can literally set the foundation for architecture to occur, we will join our efforts and explore ways to densify the urban geography, in order to create new experiences of the city and achieve higher levels of efficiency for society. This approach of Architectural Infrastructure may better balance expenses and new values for society and the environment – and address environmental concerns in a new way.

TEACHING METHODOLOGY

Studio 9 explores the critical integration of planning, design, and computational techniques within architectural design practice. This year the studio takes on the question of how architecture can use new potentials in infrastructural situations.

Using diagrammatical mapping techniques, iterative model-making, and advanced digital design, simulation and fabrication techniques, the studio will critically investigate how scenarios can be developed into built structures, supported through direct links to digital fabrication technologies, and informed by expertise in other fields.

Design strategies will be based on in-depth research. Design proposals will span from the organization of urban life to tactile relations to human interactions. Structure, materiality, fabrication, and detailing will relate to scale and context. Particular concerns include the new roles of scenarios, design and prototyping techniques and fabrication strategies in architectural practice.

Experienced and 5th year students may define their own agendas within the studio. Previous knowledge in design and modelling software is not compulsory, but preferred – computational design is supported by experienced tutors. Further support will be provided for structural engineering (Tyréns) and urban planning (the Stockholm Planning Office).

Studio 9 2015-2016 taught by:
KAYROKH MOATTAR
JONAS RUNBERGER
JULIEN DE SMEDT
ELSA WIFSTRAND

Below: Full-scale pavilion by Felipe Franco, Giulia Malesani and Francesca Pernigotti, produced in the KTH Digital Fabrication Lab and exhibited at Diploma Days, June 2015



STUDIO 10:

GLOBAL CONNECTIONS

– DWELLING, HOUSE, NEIGHBOURHOOD AND CITY

STUDIO THEME

Article 25 of the Universal Declaration of Human Rights recognises the right to housing as part of the right to an adequate standard of living. According to the UN Refugee Agency, by the end of 2013, 51.2 million individuals were forcibly displaced worldwide as a result of persecution, conflict, generalised violence, or human rights violations. Today, 783 million people do not have access to clean water and 2.5 billion do not have access to adequate sanitation facilities. Migration and informal settlements are on the increase, not only in developing countries but also as a part of the Swedish landscape. We need to analyse these phenomena, to understand their drivers and structure. We will attempt to identify values and investigate the basic built environment in geographical areas with varying cultures, climates, and building techniques. The Austrian architect Hans Hollein defined architecture as being twofold: both regulating body temperature and acting as a sign. The former, which is contained within the notion of a primary “dwelling” which provides mankind with necessary shelter, forms the point of departure in this year’s investigation in Studio 10.

Production techniques and the availability of materials will be studied through group collaborations. Informal housing projects will be analysed and the lessons learned from these

studies will inform the studio work. Students will also critically analyse development projects on their merits and develop own sustainable proposals in a variety of scales, from the house to the city.

TEACHING METHODOLOGY

The practice of the architect is increasingly complex and much of it consists of team collaboration rather than single-handed performance. We believe that group collaborations are an interesting method for learning. To live in a more common and shared environment, irrespective of where we find ourselves on our planet, requires that we must maintain an ongoing dialogue with other countries and cultures.

Our studio has been testing collaborations in Istanbul, Rabat, and last year in Cairo. Large demographic changes in North Africa and the Middle East are in focus for the EU. Our working method is to be curious, to ask pertinent questions and to avoid preconceived ideas about aesthetics or what the final result may be. We believe decision making in architectural and urban design to be rational. The skills of the architect are dependant on adequate work processes and methods. These methods can be learned and become a central tool in practice.

Studio 10 2015-2016 taught by:
ALEXIS PONTVIK
INGRID SVENKVIST

Below: Plan of Meidan Emam and Esfahan Grand
Bazaar, in Esfahan, Iran.

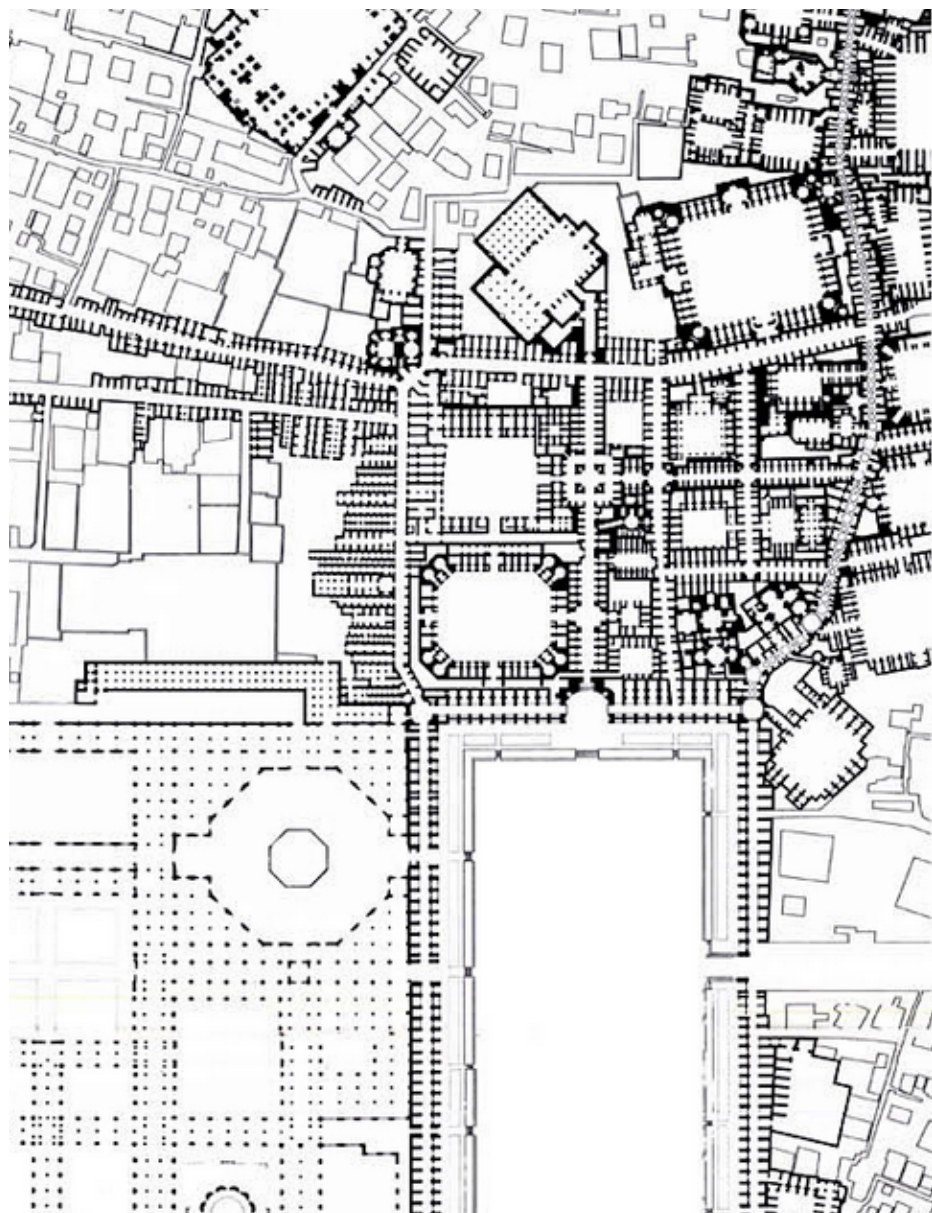

STUDIO SUPD: DIY URBANISM

THE SUPD MASTER'S PROGRAMME

SUPD is an interdisciplinary Master's programme, which takes advantage of world-leading interdepartmental competence at the KTH School of Architecture, the KTH Department of Urban and Regional Studies, and the KTH Department for Sustainable Development. Studio pedagogy emphasises task-based learning, whereby each member of the studio, with her/his competency and background, contributes situated knowledge to the studio theme.

The SUPD studio works with interdisciplinary, practice-led design research for developing critical as well as projective proposals. Projects involve collaborative and individual work supported by lectures, seminars, workshops, reviews, and group and individual tutorials with tutors and external consultants. Each term combines research-led investigations and strategic design proposals. In particular, we emphasise research *in the field*, by design and through participation. Parallel to Project 3, we offer a module in Theories and Research Methodologies addressing social sciences and design research through lectures and seminars.

2015-2016 THEME: DIY URBANISM

Do-It-Yourself (DIY) Urbanism can be seen as a testing ground for social innovation and an opportunity for social change instigated on grassroots levels. Much discussed in American cities such as San Francisco, which since the onset of the recession in 2008 have struggled through a period of economic decline and drastically reduced public resources, DIY Urbanism happens here in form of activating stalled construction sites, building temporary public plazas and parks, and urban farming, etc. Berlin is seen as another example for successful DIY Urbanism, where the specifically isolated location of the city has furthered diverse economies, an abundance of space, and a spirit of *do-it-yourself that has been* tolerated by the authorities since the late 1980s.

Although the context in Stockholm is entirely different, DIY initiatives such as the self-initiated cultural centre Cyklopen, Konsthall C, and the activities around Slakthusområdet have sprung up in recent years. The city of Stockholm has started to encourage a Swedish form of DIY urbanism, which taps into traditions of social entrepreneurship and activism. This year, we will explore the meeting grounds between the bottom-up approach of DIY urbanists and the traditional top-down planning process.

Studio SUPD 2015-2016 taught by:

ÅSA DROUGGE

JOHAN PAJU

JORDAN LANE

MEIKE SCHALK

GÖRAN LINDBERG

BETTINA SCHWALM

BRYANS MUKASA

Below: A 2015 study trip to Istanbul.



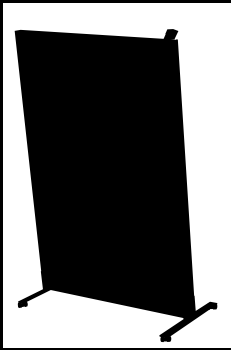

THE COVER

The figure on the cover of this catalogue is a silhouette of an exhibition screen from the KTH School of Architecture. Originally designed for the old KTH-A on Östermalmsgatan 26 in the early 1970s, the screens have recently been renovated and are frequently used for reviews and pin-ups.

THE SCHOOL

The Royal Institute of Technology School of Architecture was founded in Stockholm in 1877 and today offers architectural education at all levels, from a preparatory course in Tensta in northwestern Stockholm, to doctoral studies within the Swedish Research School in Architecture. There are currently around 550 students enrolled in the professional programmes at Basic and Advanced level.

The school has a staff of around 100 studio teachers, professors and researchers, and 15 administrative and technical employees. It has a well-equipped workshop, a digital fabrication lab and access to an extensive collection of books and journals in the KTH Library.

In 2015 the KTH-A moved to a new building on the KTH Campus, designed by KTH alumni Tham & Videgård.

2015-2016 Degree Projects by:

JOHAN AHL ELIASSON
MALIN AHLGREN BERGMAN
FRIDA ALEXANDERSON
KRISTINA BARNIŠKYTĖ
HANNA BECIROVIC
LI BIAO
MÅNS BJÖRNSKÄR
ANTON BOGÅRDH
KRISTOFFER DAHL
NATALIA DAUKSZEWICZ
INESE DINDONE
STEFANIA DINEA
ULF EDGREN
OSKAR EDSTRÖM
NOA ERICSON
HANNES ERIKSSON
MARTIN ERIKSSON
ERIKA FAGERBERG
EIRINI FARANTATOU
DANIEL FLIMEL
MATTIAS FLOXNER
ARVID FORSBERG
MARIA FORSMAN
FELIPE FRANCO
LAURA GIOANETTI
MARIA GLASSEL
ALEXEY GOLITSYN
LEONIE GREINER
ALBIN GRIND
HILDUR GUÐMUNDSDÓTTIR
MIKAEL HASSEL
ARON HEINEMANN
ANNA HOFFMAN
ALVA HULT
LOUISE HUSMAN
JOHANNA JACOBSON

EIRA JACOBSSON
ARVID JANSSON
GABRIEL JOHANNESON
GABRIEL JONSSON NORDBÄCK
VILIUS JUKNEVICIUS
STEFANIA KAPSAKSKI
MARIA KARAMANOU
ANNA-MI KARLSUDD
OKSANA KOLBOVSKAJA
JAKUB KOLEC
KONSTANTINA KONSTANTINOU
MÅRTEN KYRKLUND
MADELENE LARSSON
TOBIAS LIDMAN
ISABELLE LINDBLAD
JOSEFIN LINDBLOM
VALTER LINDGREN
DAVID LINDMARK
AXEL LINDQVIST
JOHAN LINGMARK
ASTRID LINNÉR
PONTUS LJUNGBERG
FELIX LOTZ
YANG LUO
EMILIA LYONS
SARA MALM
LISA MELIN MAHFOUZ
JESPER MELLGREN
EMMA MOLITOR
BRYANS MUKASA
PAVEL MUSAMBA
EMILIE NÄSLUND
JOHAN NILSSON
TOBIAS NORENSTEDT
EVA NYBERG
ANDREAS NYSTRÖM

BENJAMIN ONOSZKO
LISA PALM
FRANCESCA PERNIGOTTI
JACK PHIPPS
HILLEVI ROBERTSSON QUINN
ANNA RODIN
MATILDA SCHUMAN
MY SIVESSON
ALEXIA STAAF
MARIA-ANTONIA STAMOULI
ANDERS STENHOLM
HJALMAR STENLUND
FRIDA STJERNQVIST
KAMELIYA STOYANOVA
LOVA STRINDBERG
ELSA KRISTINA SUNDIN
JOHANNES SVERLANDER
GUSTAV SVÄRDH WEIDEL
DENNIS SÖDERHOLM
BEATRIZ DE UÑA BÓVEDA
JAKOB VALENTIN
JOAKIM WADENHOLT
GUSTAV WALLERIUS
LOVISA WALLGREN
HJALMAR WEDHOLM
ANNA WEGLIN ELENIOUS
RASMUS WESTMAN
FANNY WETTERROT
JOEL YNGVESSON
TIANLE YU
DANIEL ZETTERBERG
MARINA ZIANKOULI
OSKAR ÅSTRÖM
RAKEL ÖSTLUND

External Jury

ANTTI AHLAVA
CARLOS AROYO
KATARINA BONNEVIER
IÑAQUI CARNICERO
DAGUR EGGERTSON
LIZA FIOR
MIA HÄGG

SAM JACOB
SHIRA JACOBS
KAROLINA KEYZER
LESLEY LOKKO
ALI MALKAWI
LAURA NOVO DE AZEVEDO
LORENA DEL RIO

ANDREA SIMITCH
JAN SCHOTT
LISE-LOTT SÖDERLUND
BOLLE THAM
MALIN ZIMM