

Procurement methods and specifications

- influence on pavement design and project management

Robert Lundström
May 16th 2013

Topics

1. Introduction
2. Procurement methods
3. Requirements and specifications
4. Arguments regarding procurement methods
5. Procurement methods and implications: technical design and project/knowledge management

Introduction

Obtaining bread.....

Reciepe:

600 ml milk

100 g butter

50 g yeast

2 tsk. sugar

1 tsk. salt

1 tsk. cinemon

1 kg mjöl



Methodology:

Varm the milk together with the butter until it has melted. Dissolve the yeast in water and add the remaining ingrediencs. Put it into the oven at 175 degrees for 30 minutes.

Make or buy decisions...

- Pins
- Bread
- Car
- House
- Nuclear powerplant



1. Complexity
2. Uniqueness
3. Degree of transaction specific investment

TCE (Williamson, 1985)

Uncertainty. Three important aspects:

- Transaction frequency
- Transaction-specific investments
- Opportunism

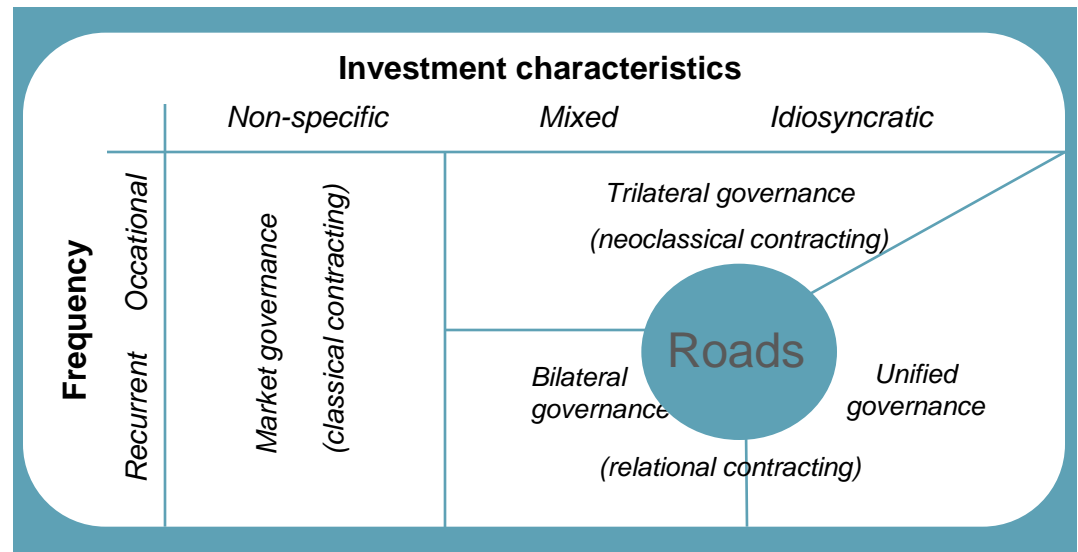

Projects

- Another source of uncertainty

..the construction industry typically engage in organizational systems lying somewhere between traditional market and hierarchy models, normally procured based on a market model, while subsequently managed within a hierarchical but temporary project context, which depends on buying procedure and contract type used...

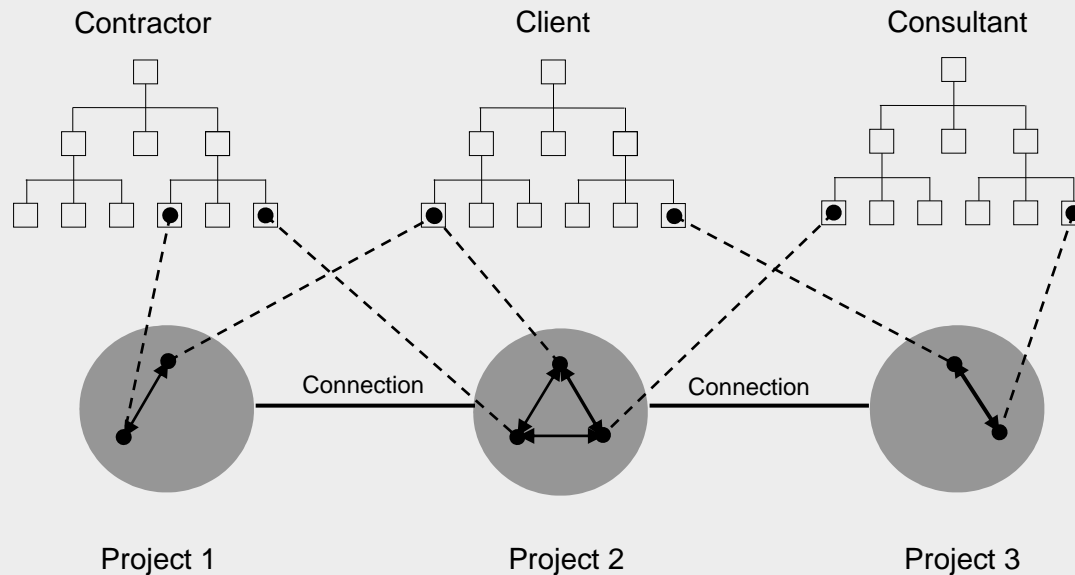

Procurement methods

Procurement methods

- a definition

i.e....the way a client invites contractors to tendering, including the type of contract, requirements and payment mechanism used.

Procurement methods

1. Contract length and scope of activities contracted

Design-Bid-Build (D-B-B)

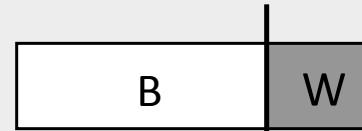

Design-Build (D-B)

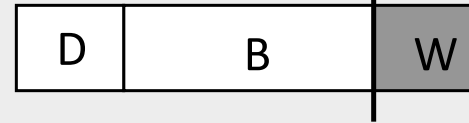

Design-Build-Maintain (D-B-M)

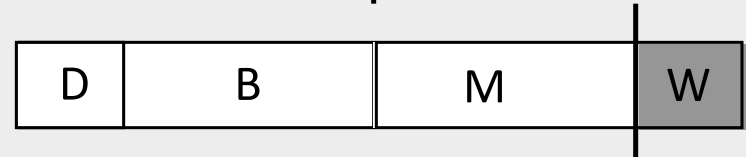

Historical reflection on road procurement

- Most contracts has historically been the traditional Design-bid-build (DBB)
- The number of D-B (-M) projects is increasing

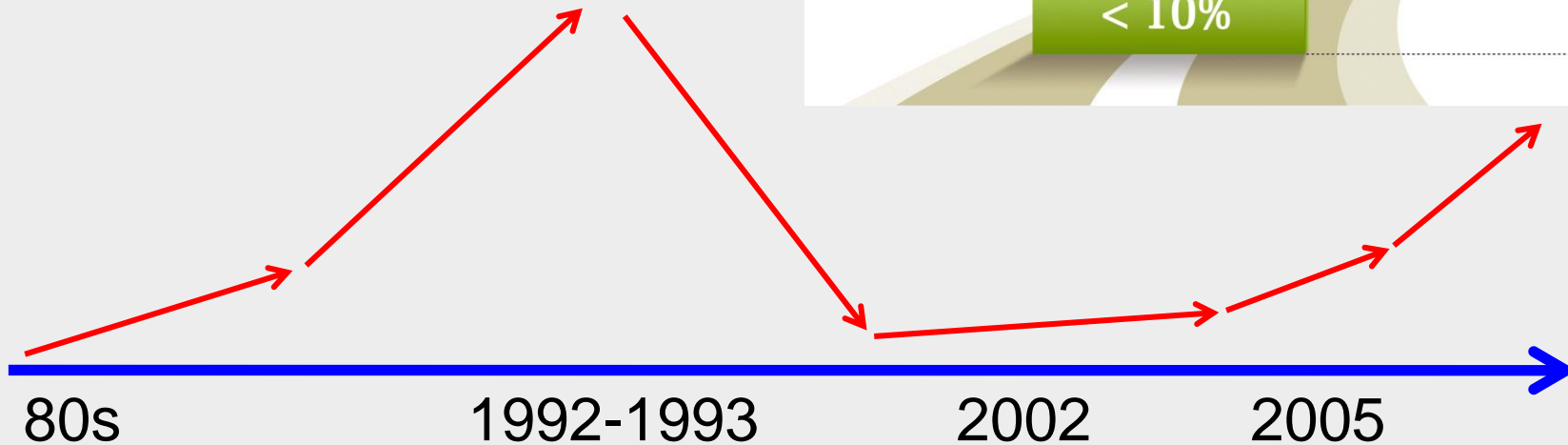
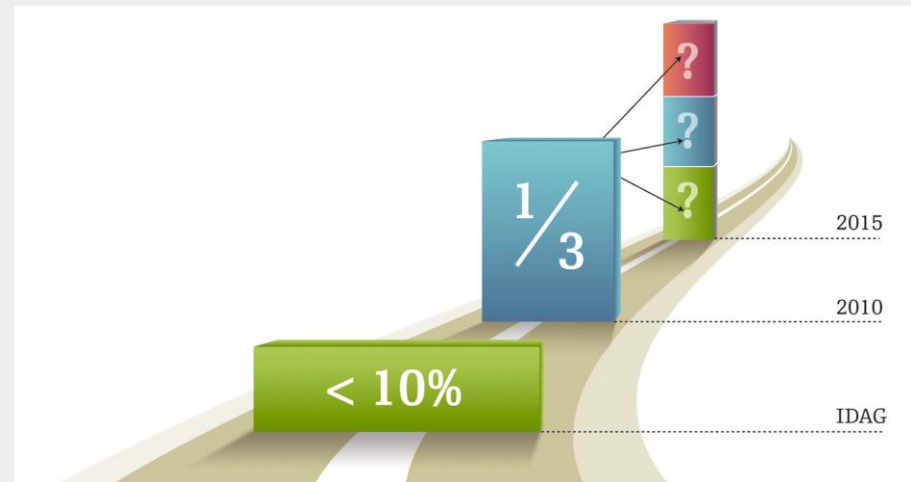

Procurement methods

- Effect on project organization

D-B-B

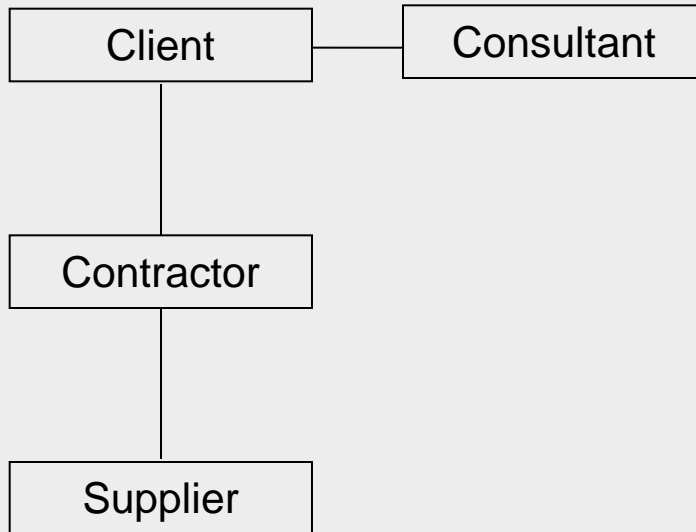

D-B(-M)

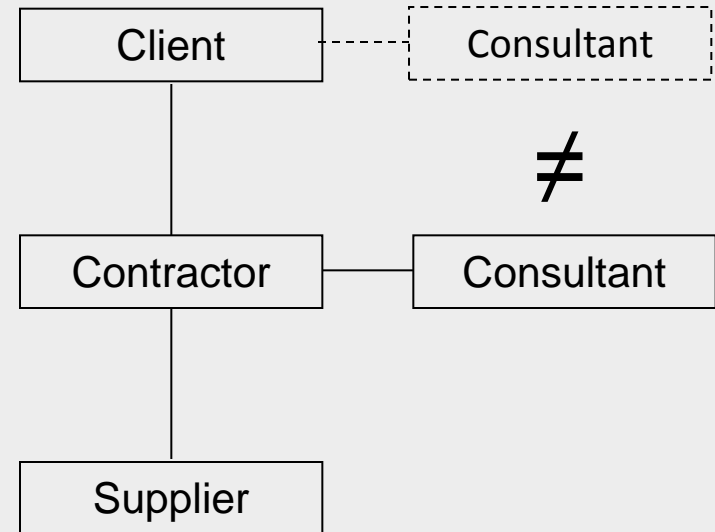

Procurement methods

- effect on specifications

- The D-B approach can be characterized by that the product is specified by *performance* requirements, and consequently, not as in the case of the D-B-B approach by *procedural* specifications.

Requirements and specifications

Contractual aspects on specifications

”sharp in by clear agreement, sharp out by clear performance”

1. All measurement/testing should be based on a METHOD, i.e. clearly refer to which standard (e.g. SS-EN) that is applicable.
2. REQUIREMENT LEVEL should be clearly addressed.
3. CONSEQUENCE that a given defect results in.

Procurement methods

2. Requirements and specifications used

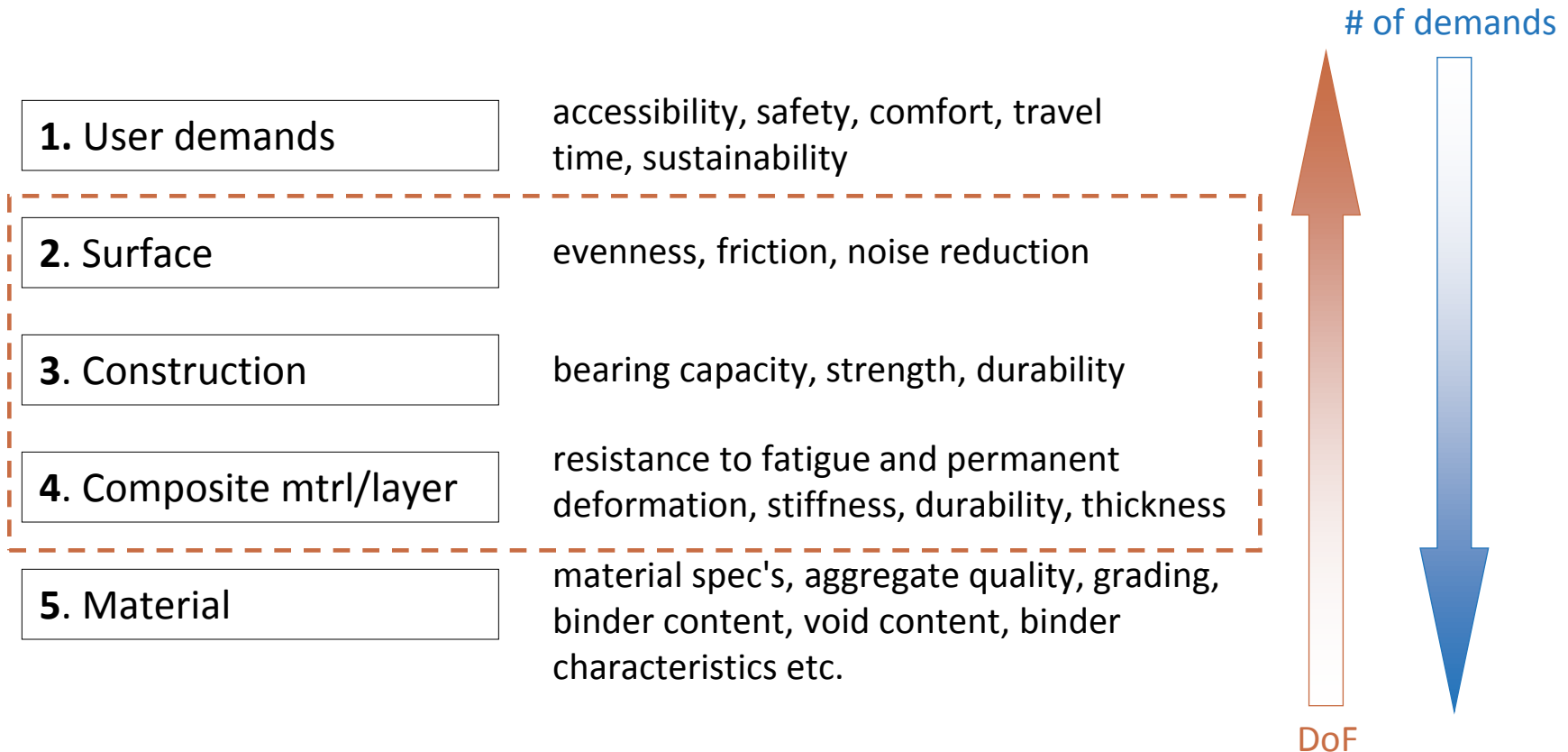

Mix design objectives by procedural specifications

Address the following nominal parameters:

- Deformation resistance (stability)
- Fatigue resistance
- Low temperature cracking resistance
- Durability
- Moisture damage resistance (additives: portland cement, amines)
- Skid resistance, friction
- Workability

Main mixture types

- Dense graded asphalt
- Stone mastic asphalt
- Open-graded asphalt
- Mastic asphalt (gussasphalt)

Differ in particle size distribution and binder content

Parameters distinguishing different mixtures

- Binder content
- Binder type
- Void content
- Stone aggregate quality
- Gradation
- Additives

Binder contents

[%-by weight]

- Dense graded 6-7
- Stone mastic 5.5-7.5
- Open-graded 5.5 -7
- Mastic 7-9

Bitumen specifications...

- Penetration grading
- Viscosity grading
- Superpave performance grading
- and more...combinations etc.

...and test methods used, e.g:

Sweden (Europe)

- Penetration@25 °C
- Softening point
- Resistance to hardening (RTFOT): retained penetration, Δ Softening point, change of mass
- Flash point
- Solubility
- Viscosity@60 and 135 °C
- Fraass breaking point

USA (pg)

- Viscosity
- Complex shear modulus
- Low temp. stiffness
- RTFO Aging
- PAV Aging
- Flash Point

Example: Penetration grade

- 40/60
- **50/70**
- **70/100**
- **100/150**
- **160/220**
- 330/430



Temperature,
traffic

Particle size distribution

- Sieve analysis consists of weighing an aggregate sample and passing it through a series of sieves.
- The material retained on each sieve is weighed and compared to the total sample mass.
- Particle size distribution is expressed as percent passing by weight on each sieve size.



Comparison regarding particle size distribution

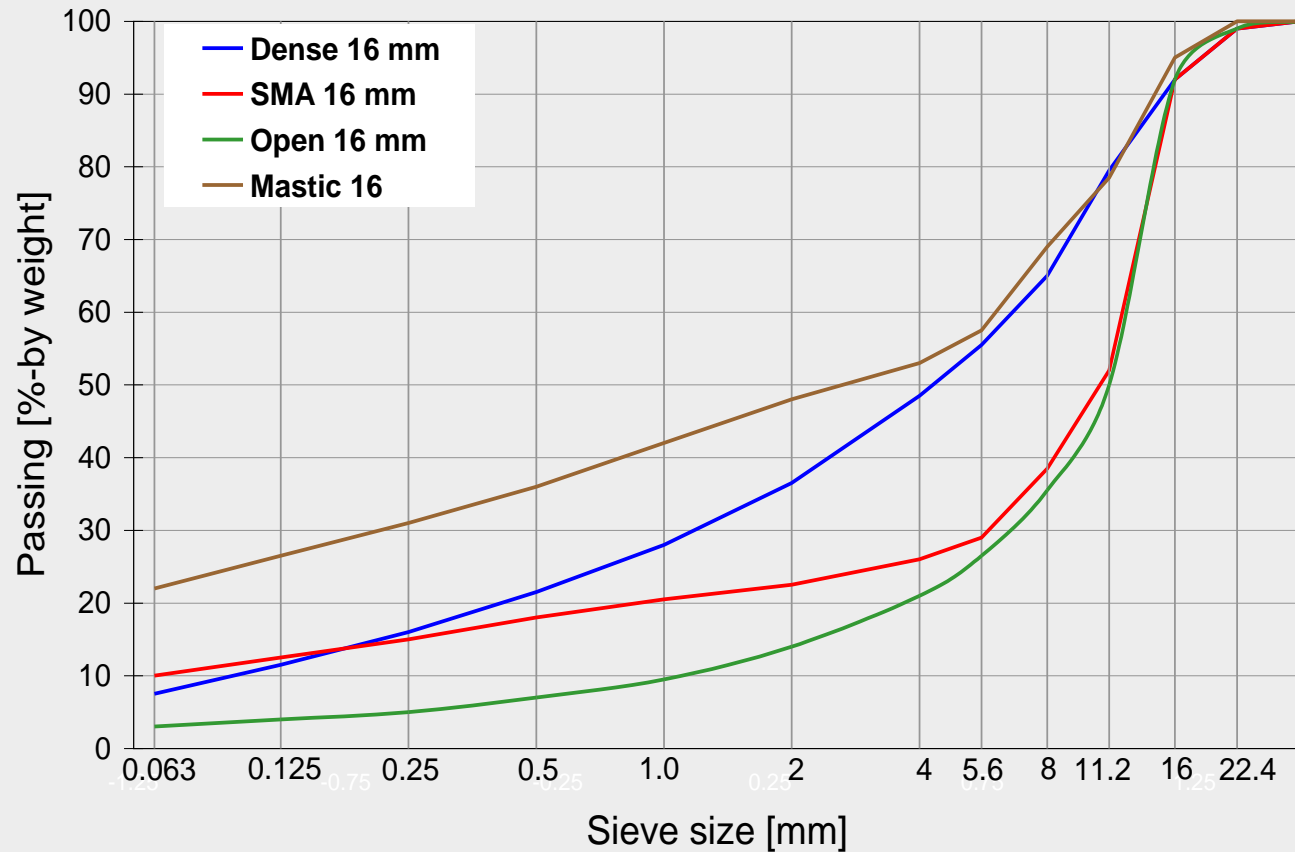

Performance specifications

- Measurement of field behavior
- Preferably, relates to driver comfort, security, speed etc.
- Mainly based on surface characteristics:
 - ruts
 - IRI

Road surface characteristics

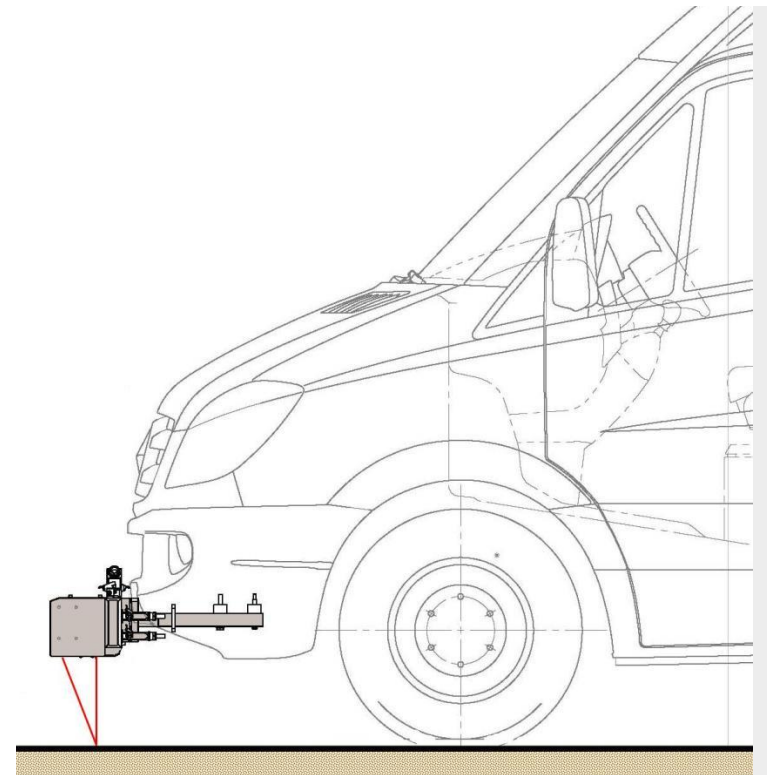
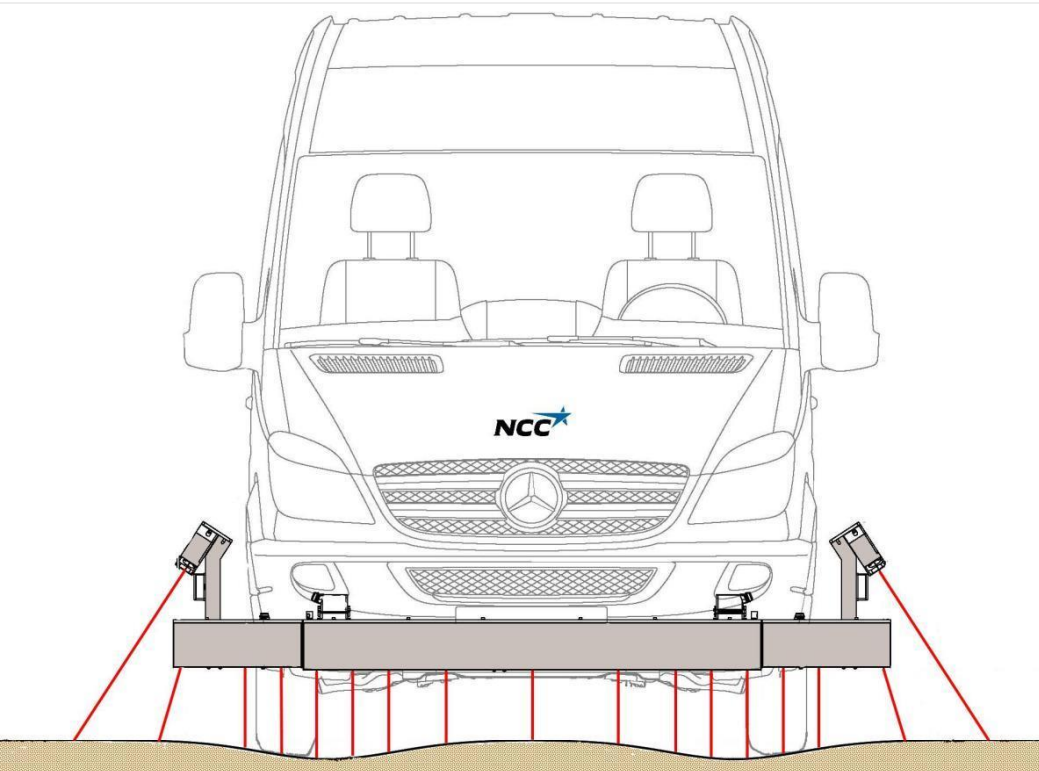

Longitudinal and transversal evenness

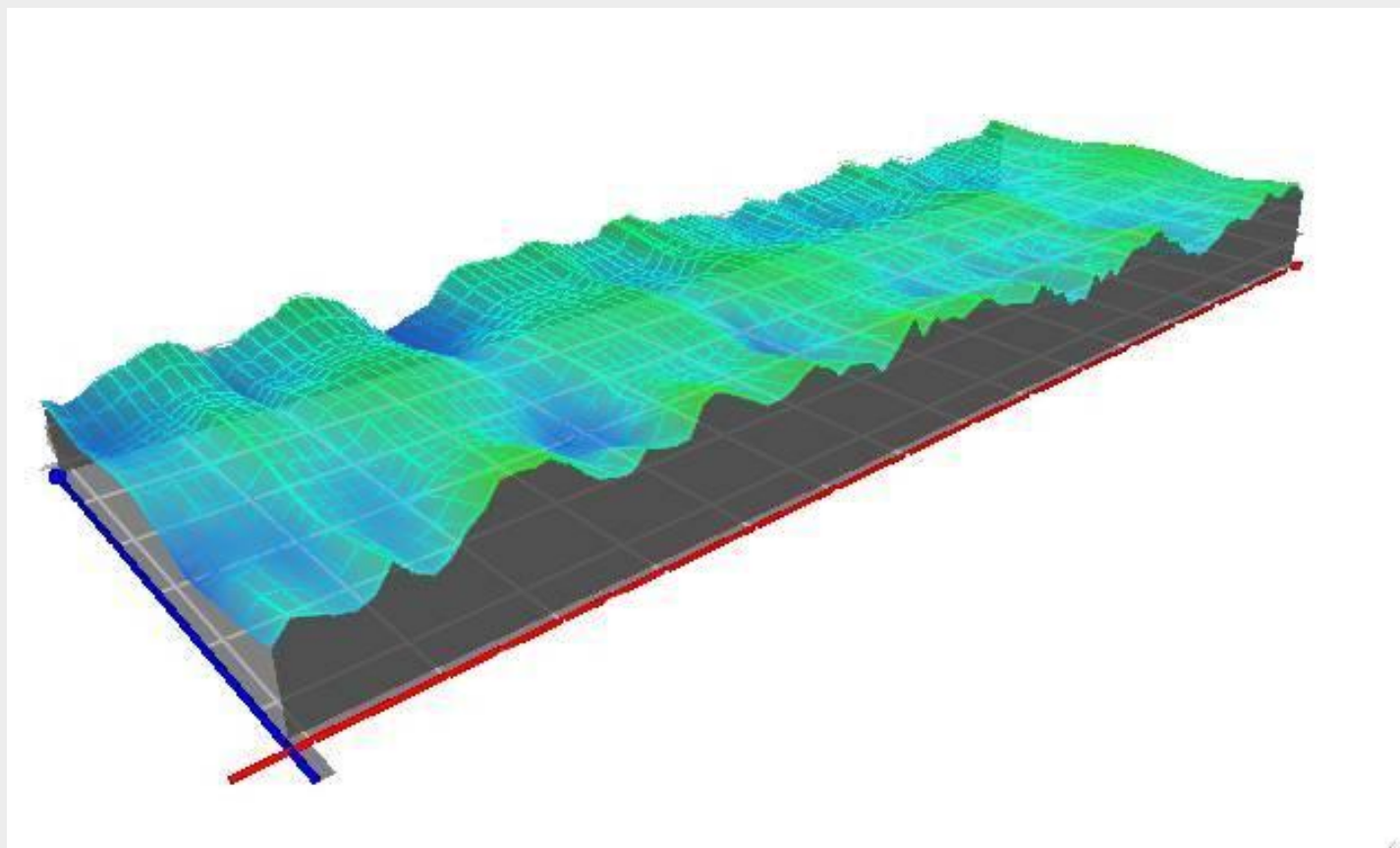

Characterizing different parameters

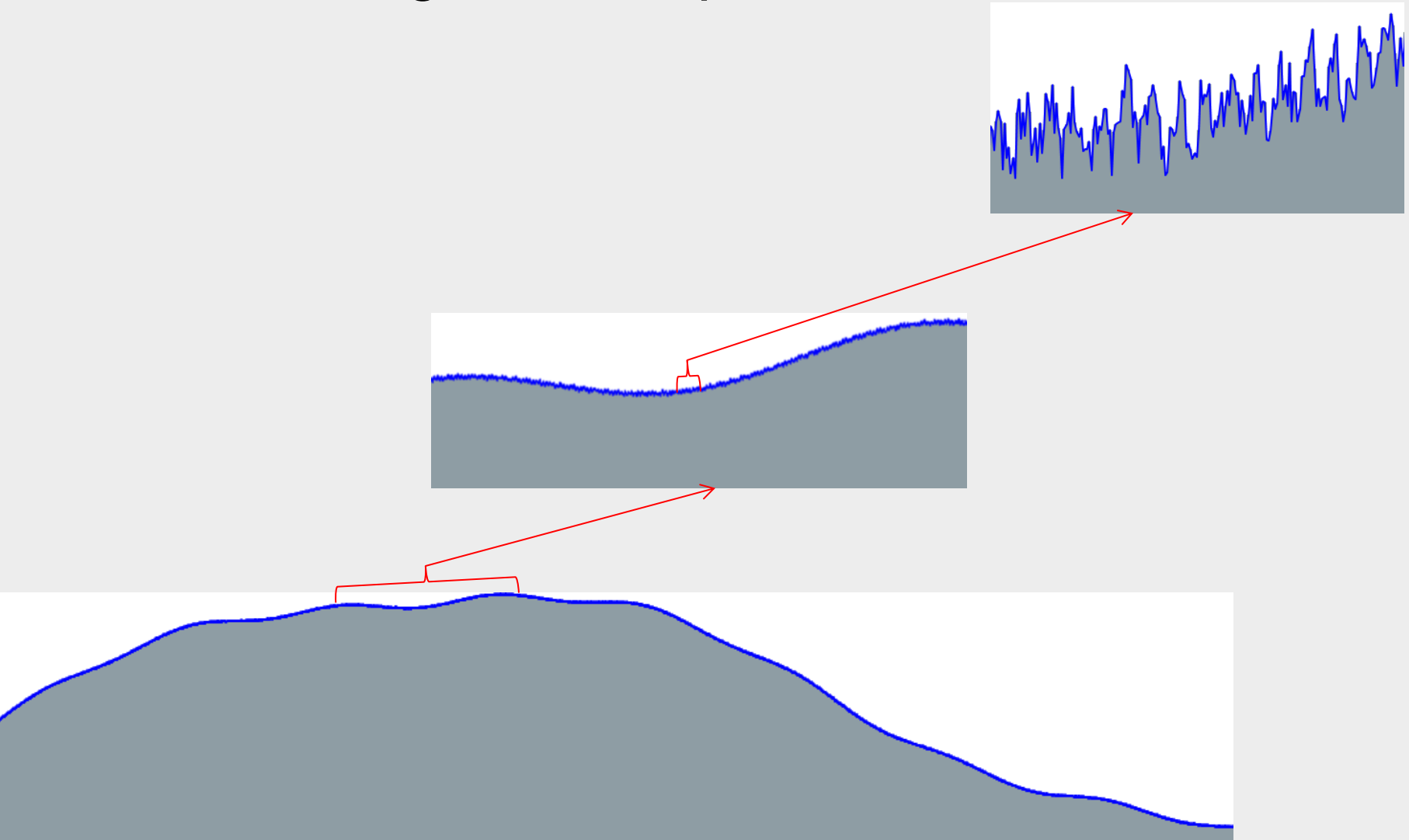

IRI – characterization of longitudinal evenness

- Simulation of a quarter car running at 80 km/h
- Accumulated movement between body and wheel divided by distance (observational distance)

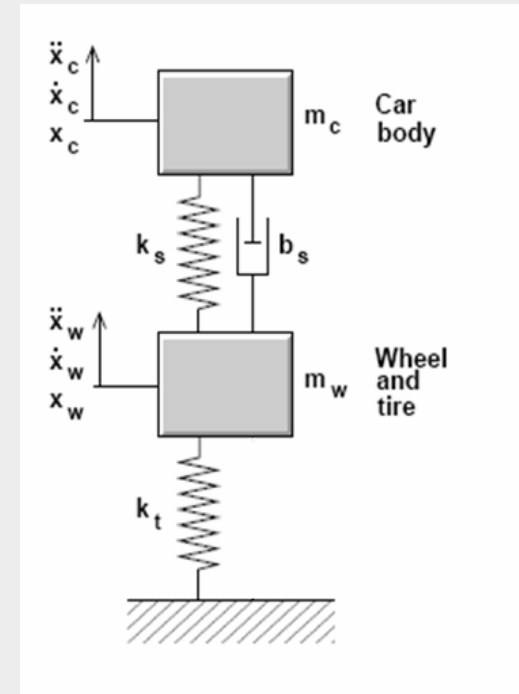
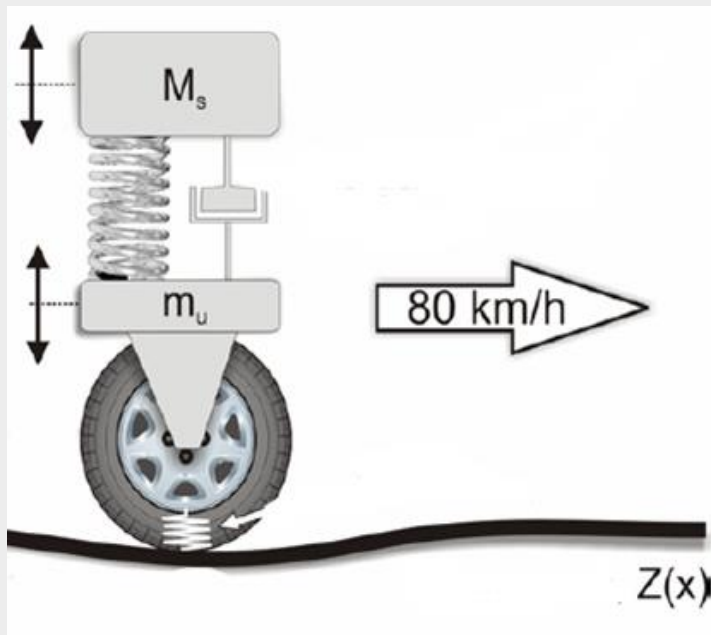

IRI-measurement

- example of results

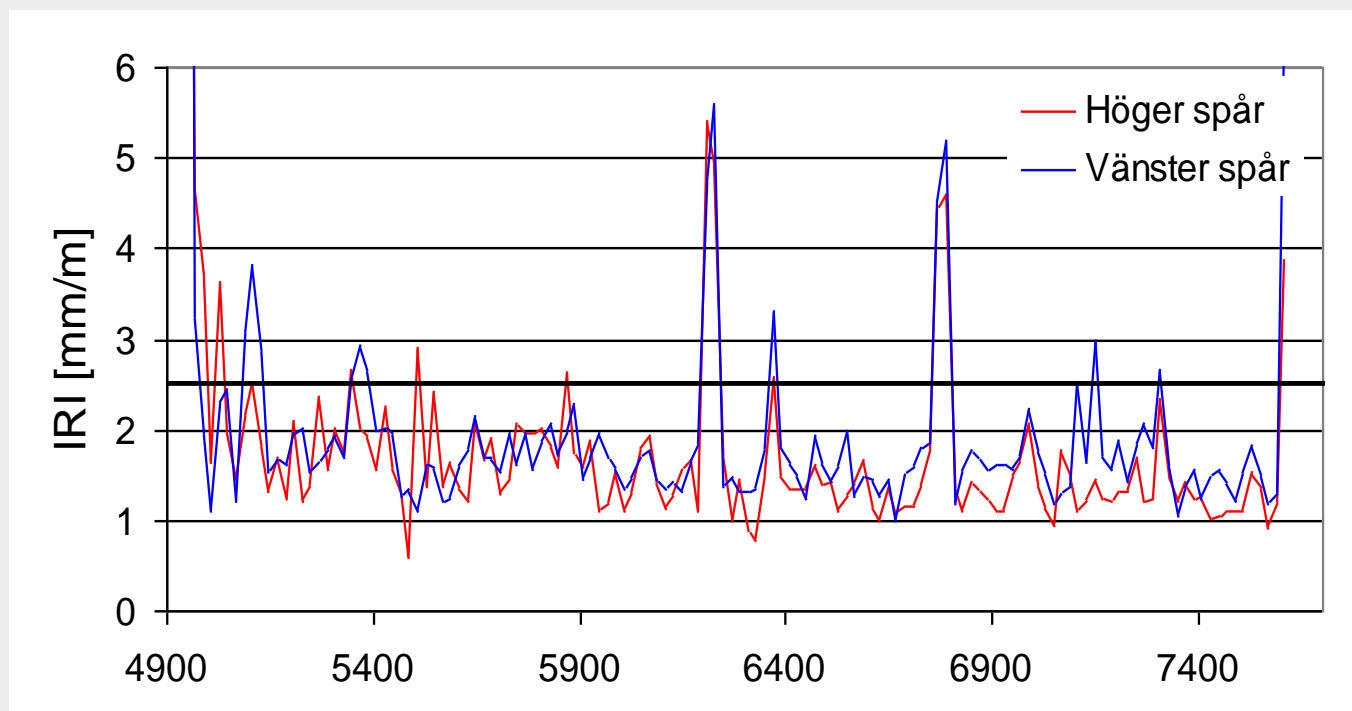

Measurement & evaluation

- initial longitudinal evenness (P95)

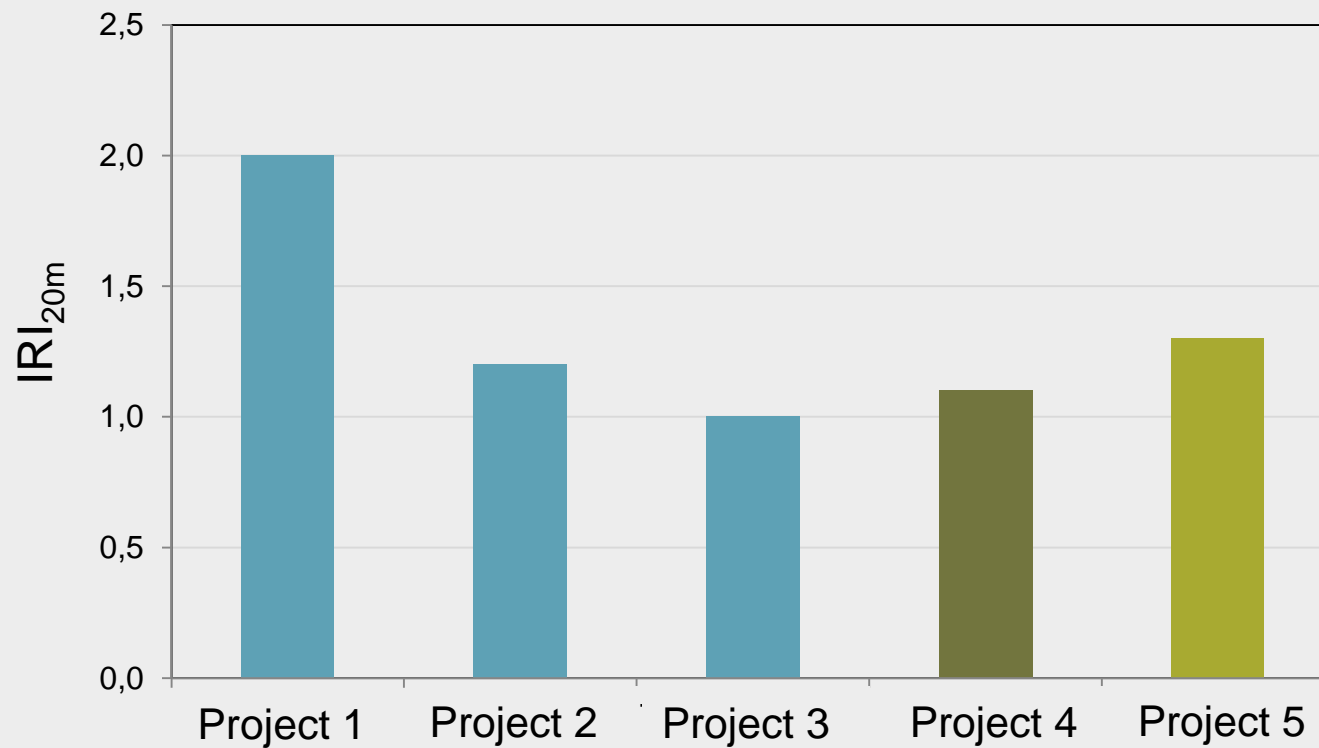

Transversal evenness - rut

- Models for characterizing rut depth

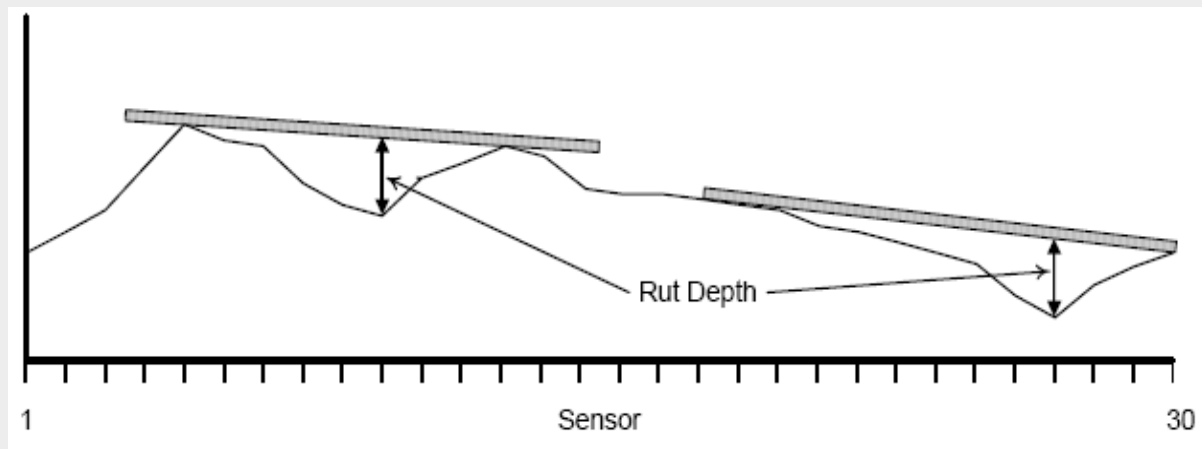
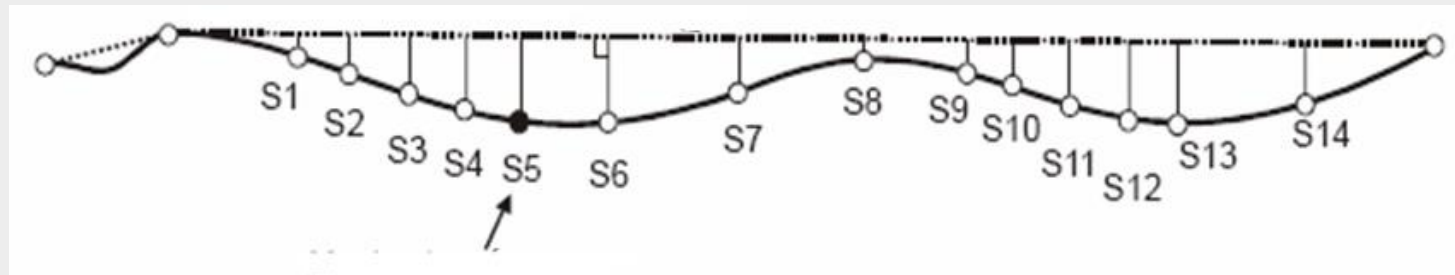

Measurement & evaluation

- initial transversal evenness (P95)

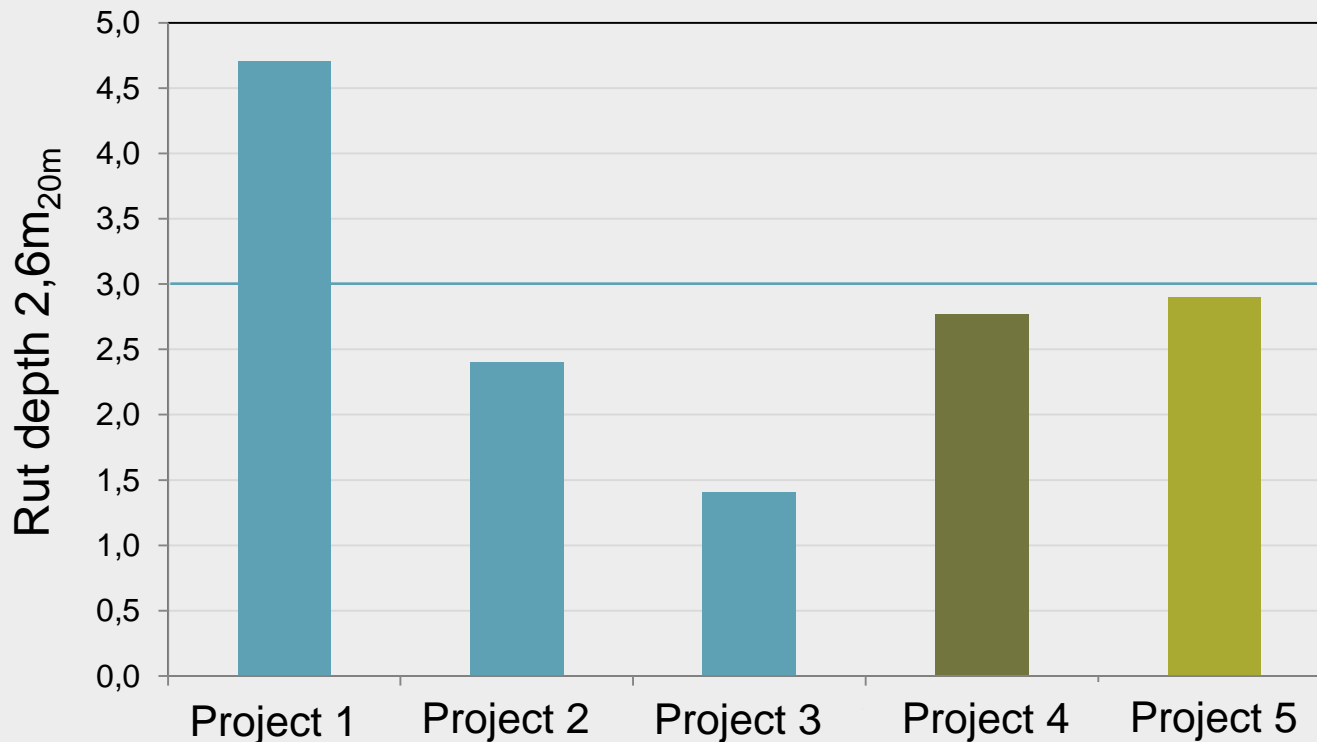

Measurement, prediction & evaluation - estimating performance and risk

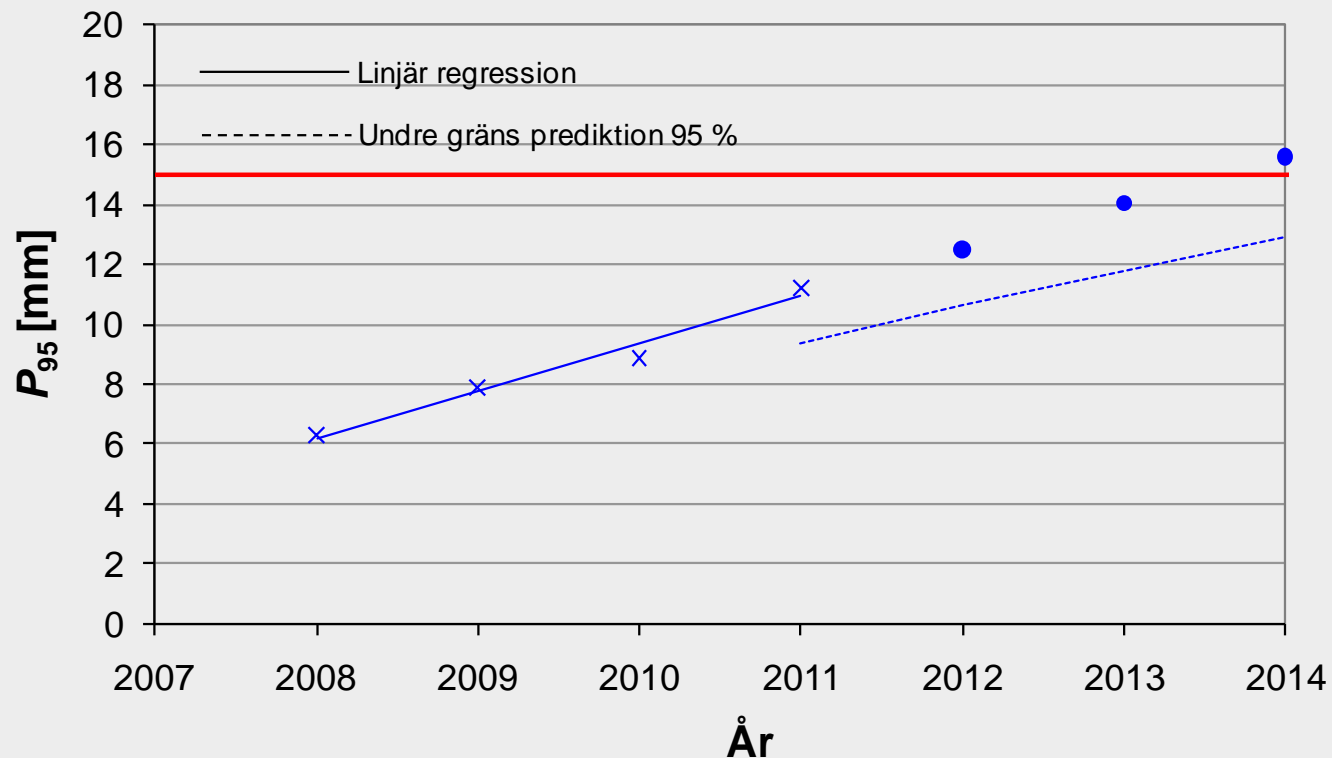

Arguments regarding procurement methods

Procurement methods

- 5 basic arguments where main contractors often are pro D-B and other actors emphasize cons

- The single-point responsibility
- Delivery time
- Quality
- Cost
- Price certainty

Single-point responsibility

- + High degree of integration of design and build activities.
- + Less risks for client since contractor assumes higher responsibility.
- + Simpler, one counterpart (bilateral governance).
- + Contractor better suited to assess certain uncertainties (e.g. climatic and site- specific circumstances).
- + Less conflicts due to contractor's design responsibility.

- Down-played role of consultants.
- Difficult to monitor/safeguard the construction works.
- Difficult for clients to articulate technical solutions.
- Compromised design.

Delivery time

- + Parallel design and construction.
- + Active design during construction.
- + Extended contractor responsibility: less re-design.
- + Empirical support.

Quality

- + Experiences of previous projects becomes more important.
- + Increased commitment from contractors.
- + Promotes technical development.
- + Logical connection between performance specification and user demands.
- + Extended contractor responsibility: less re-design.

- Quality may be compromised due to cost concerns.
- Weak empirical support.



Motives to utilize D-B(-M)

Increased life-length of 10-15%

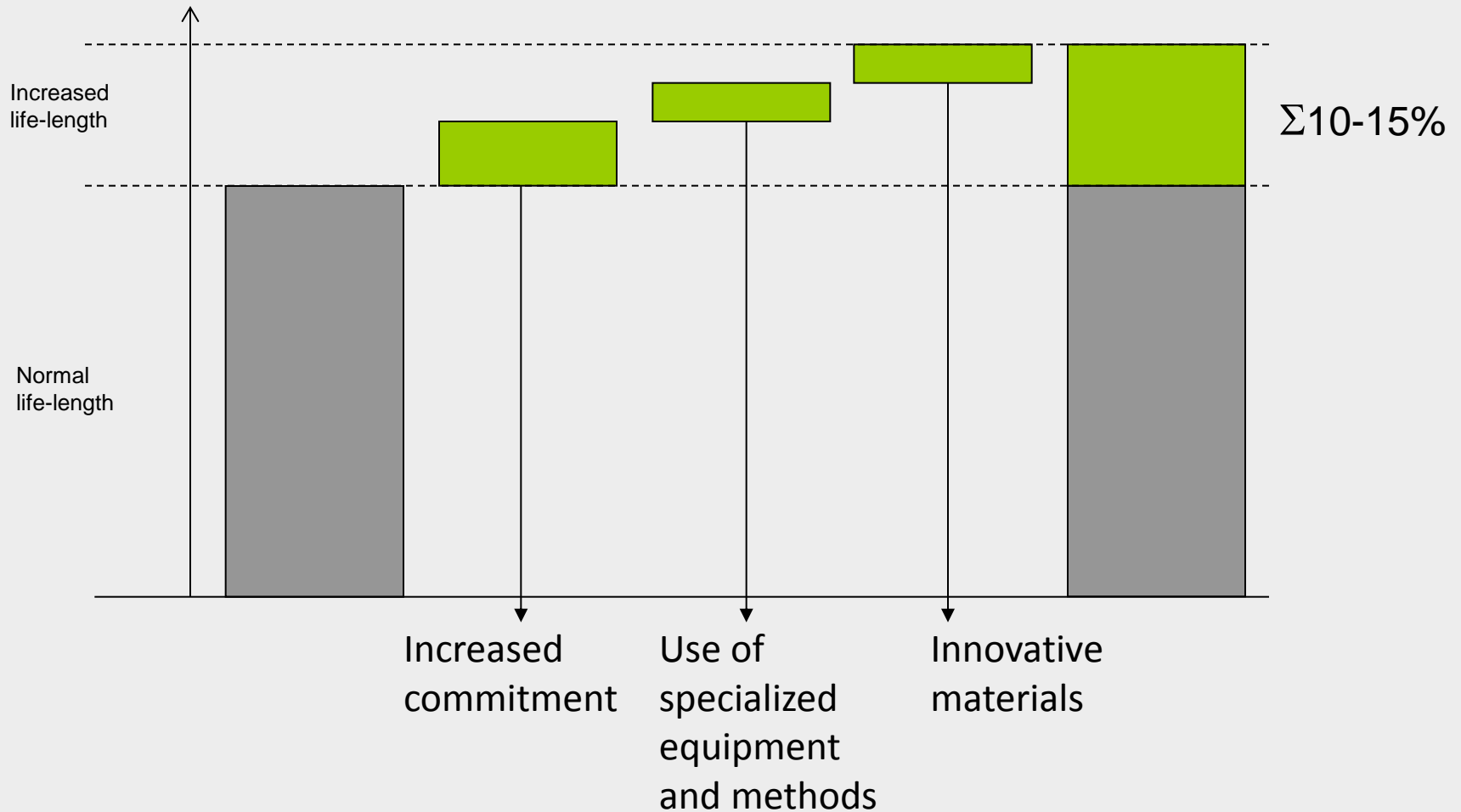

Costs

- + Life-cycle costs rather than investment costs.
- + Active design reduces costs.
- + Earlier completion provides access to the facility.
- + Competition based on technical solutions reduces risks of illegal cooperation.
- + Price dumping becomes difficult.

- In D-B-B it is easier to calculate bids and to evaluate them.
- Number of competitors due to design capacity?
- Inconclusive empirical support.

Price certainty

- + D-B projects implies responsibility for contractor regarding design and construction and, hence, less additions and change orders.
- D-B is based on incomplete drawings and descriptions. Consequently, renegotiations may occur.

Procurement methods and basic logics

Design-bid-build

- Classic economics; focus on:
 - Price
 - Many bidders
 - Full information (detailed spec's)
 - Homogenous products (same offer)

Design-Build(-Maintain)

- Evolutionary economics :
 - Dynamic (Schumpeterian competition)
 - Learning- and knowledge perspective
 - Innovation

Procurement methods:

- implications for technical design and project/knowledge management

Traditional ME-design

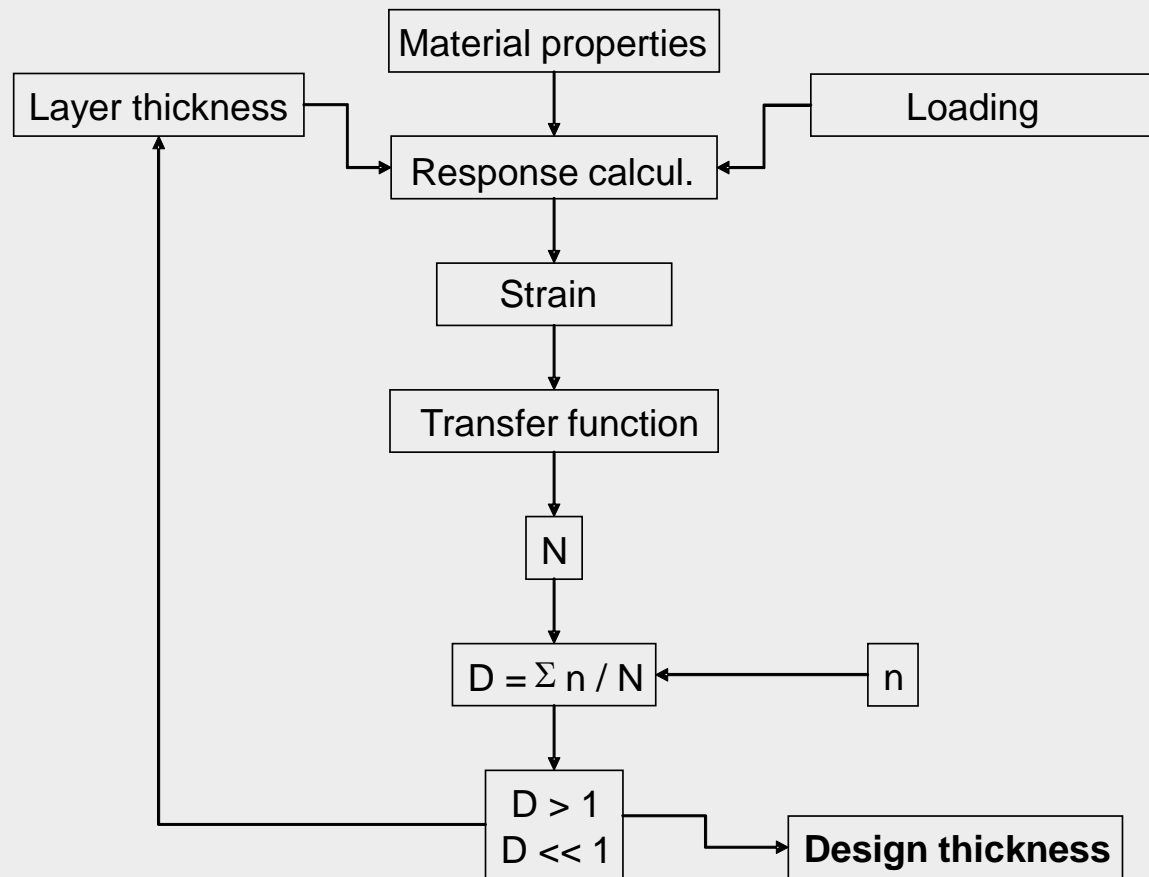

Flexible pavement design in D-B-B projects - reflections

- Mainly based on nominal material properties (not real).
- Supports existing technical standards and descriptions (procedural specifications).
- Weak empirical correlation (difficult to predict performance of individual projects).
- Difficult to utilize new materials.

Conclusion: Mainly institutional tool providing clear responsibilities among actors rather than technical tool able to predict performance of a given road project.

Flexible pavement design in D-B(-M) projects - reflections

- Existing design tools lack ability to predict performance (=technical uncertainty)
- A fundamental aim of D-B(-M) projects: introduce new materials and production methods and requirements are associated to real performance of the project.
- **How..?**

Measurement, prediction & evaluation

- estimating performance and risk by performance specifications

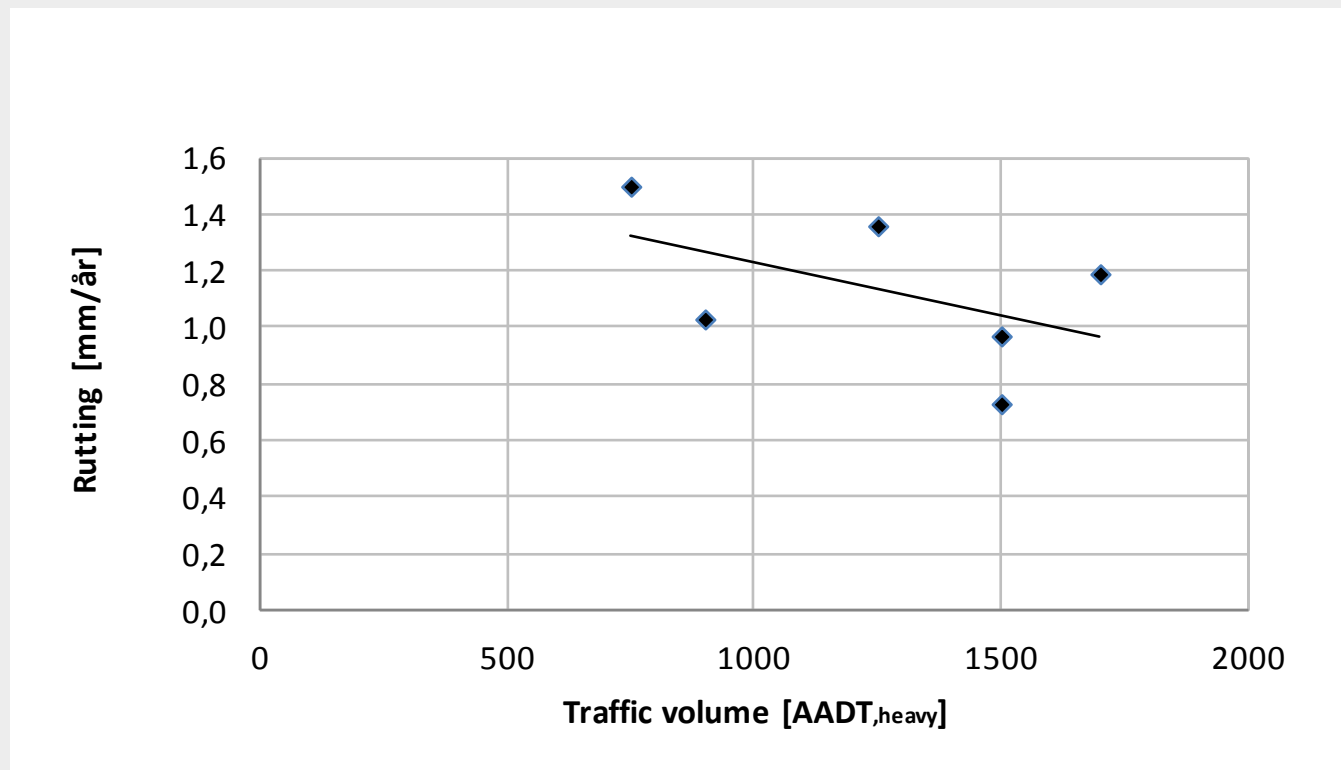

Example: rate of rutting for 6 highways

Procurement methods and contract types

- Risk, uncertainty, profit for contractors

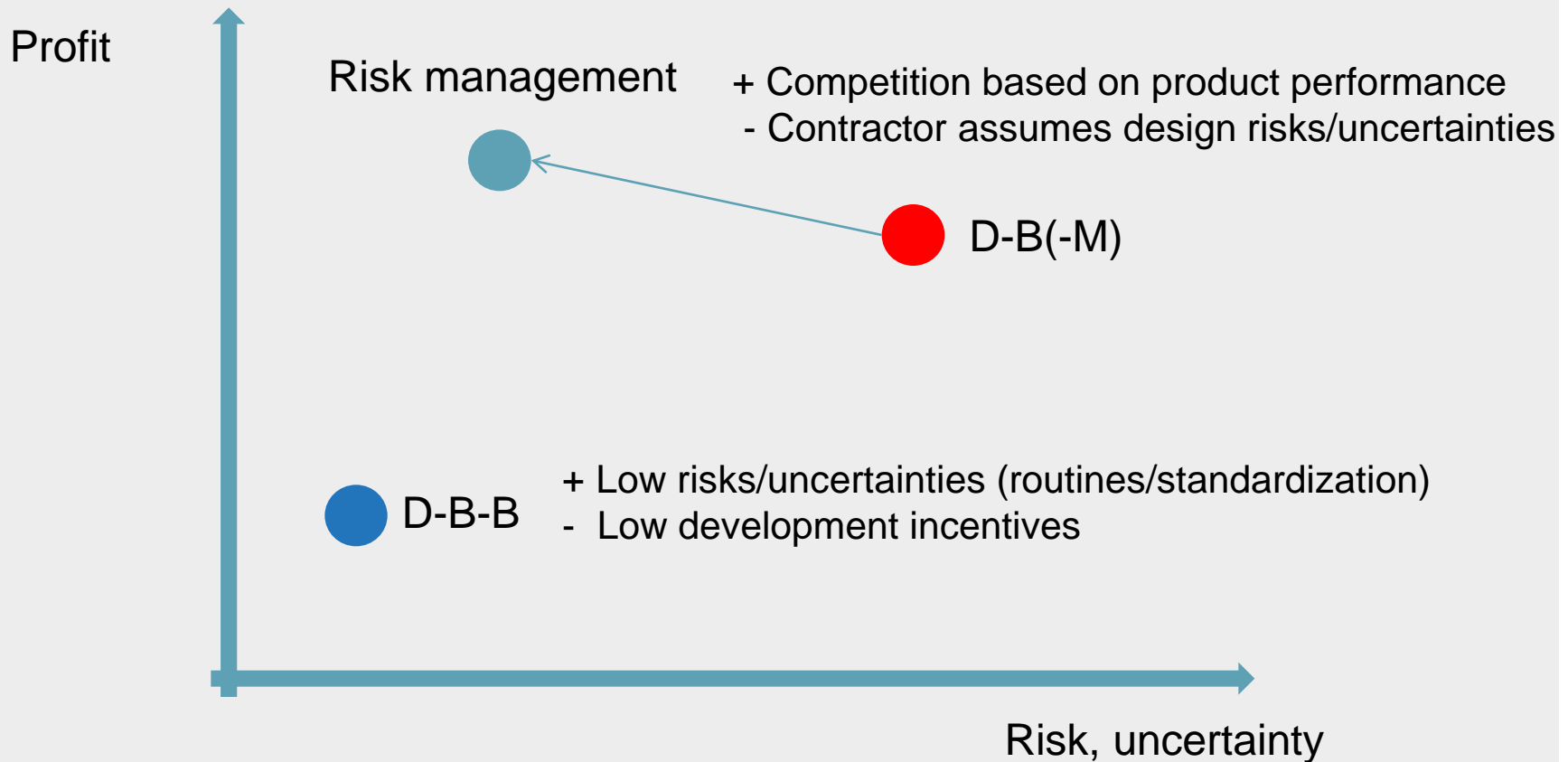

Procurement methods and design spaces

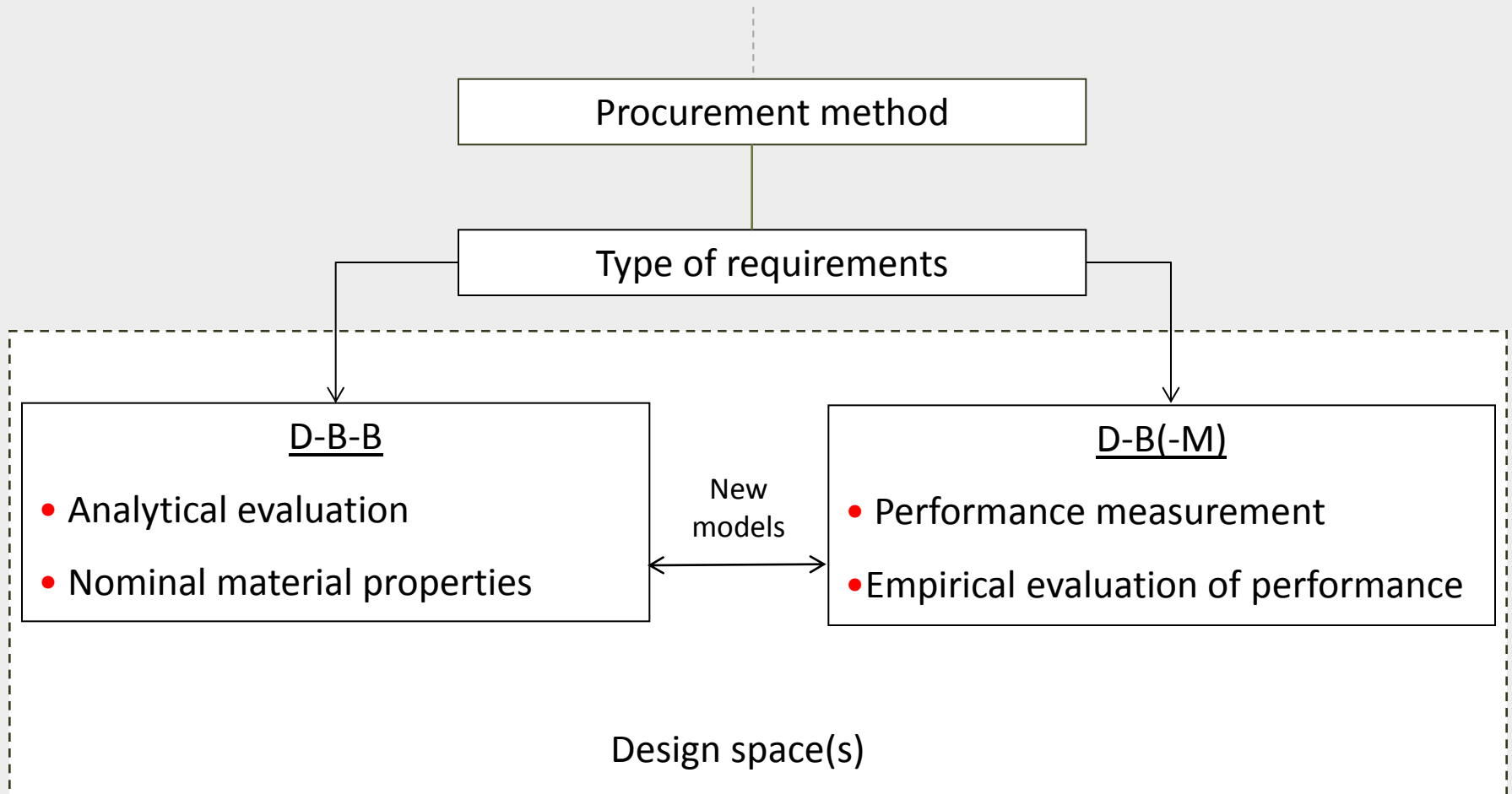

Project management

- design needs continuous knowledge transfer

- D-B-B
- D-B(-M)

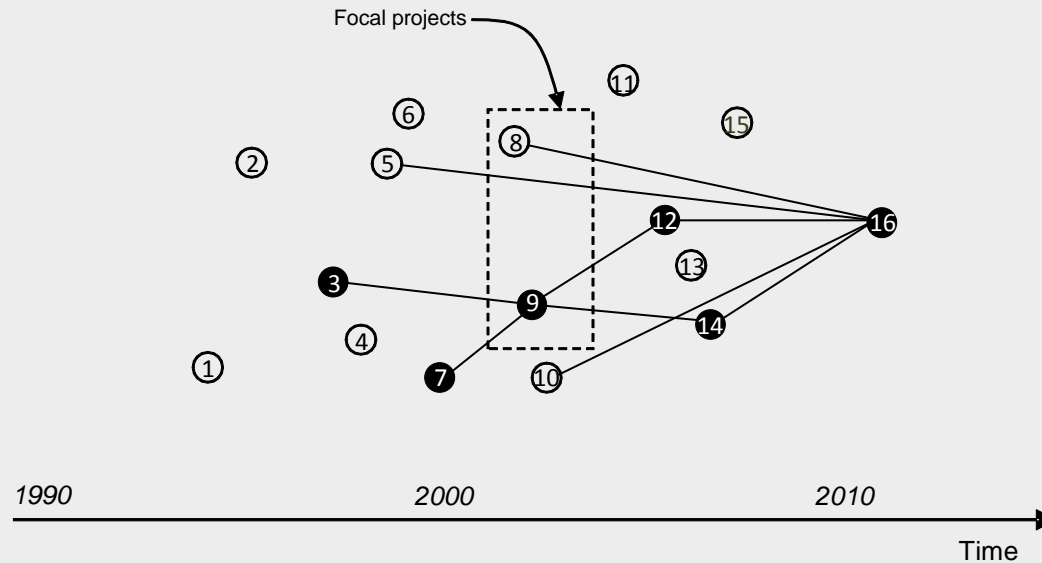

Knowledge management

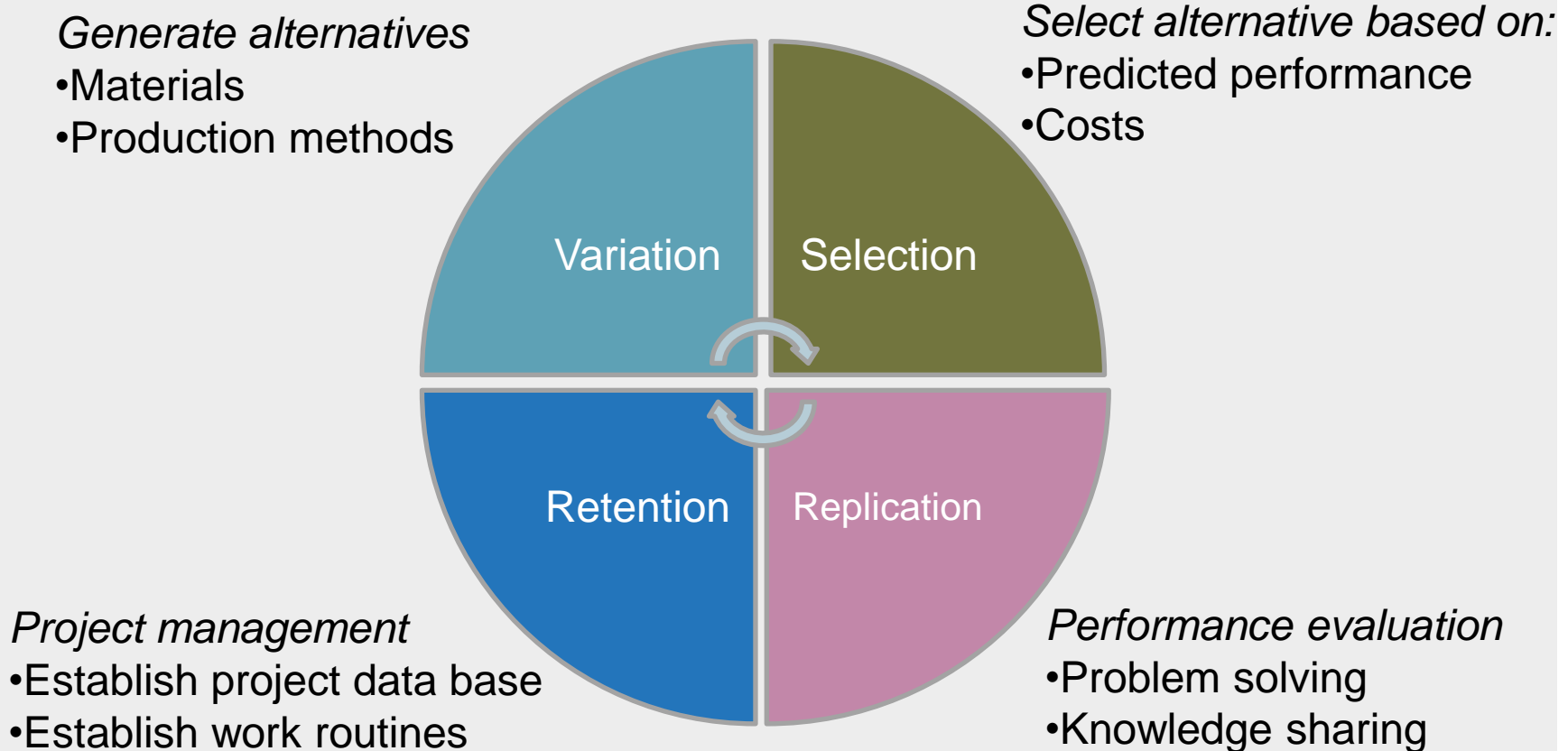

Conclusions:

- Different procurement methods exist.
- Each is associated with both pros and cons.
- D-B(-M) projects provide possibilities to product/process differentiation but also higher risk/uncertainty.
- Choice of technical solution in D-B(-M) requires risk and cost assessment by empirical inquiry rather than predetermined solutions based on proc. specs.
- Performance requirements of a given road project is comparable with other projects.
- Knowledge management is necessary to determine whether and to what extent a given product portfolio is competitive.
- Explorative learning is in general more likely to occur/necessary if a mix of different procurement methods is practiced – different procurement methods support each other.